

Hot food in focus.

Stayhot
Price List & Product Catalogue
2019-20

Stayhot Products 2019-20

STAYHOT

The prices in this catalogue are valid from 1 September 2019, and are set in Euros (€) excluding VAT.

Stayhot AB reserves the right to change prices, descriptions, modify, or substitute products without notice.

Stayhot Products

2019-20

For over 30 years, we at Stayhot have dedicated our focus and energy into creating innovative and reliable products for restaurant kitchens that stand the test of time, even in the most demanding of environments.



Contents

← Heat Lamp Classic 1224
Sovel / Sickla Köpcenter, Stockholm

Heating	
Heat Lamps	08
Strip Heaters	48
Hot Trays	54
Soup Heaters	56
Cooling	
Chill Trays	60
Heating & Cooling	
Combi Plates	66
Cold Plates	76
Hot Plates	80
Combi Wells	86
Ice Plates	92
Everything Else	
Food Preparation	94
Cutting Boards	102
Bill Rails	104
Plate Heaters	105
Spare Parts	106
About Us	
Our History	114
Contact Details	115

Whether in the kitchen, during a catering event or at the lunch buffet, our wide variety of products will ensure the food stays appetisingly hot and at a safe temperature. In this section you will find our heat lamps, strip warmers, hot trays and more.



1A

Heat Lamp Focus

Restaurant Norobata / Grow Hotel
Photo: Jonas Lindström
↑

*Heat Lamp Focus —
designed for the
restaurants of tomorrow.*

For us, the heat lamp in the restaurant is a tool that puts the food in focus and provides some well needed respite in lively kitchens. We kept this in mind when we set out to create Stayhot Focus; the latest addition to our heat lamp family. ————— Designed and manufactured by us in Sweden, these new heat lamps pay homage to traditional forms, albeit with contemporary details.



Heat Lamp Focus Model RO

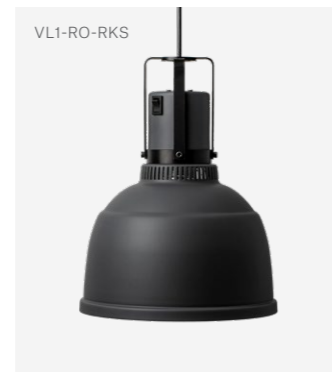
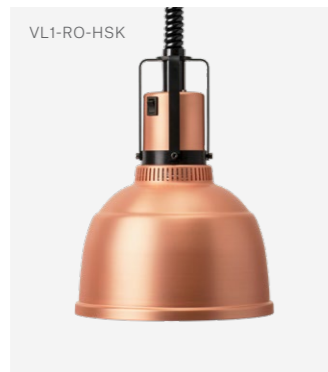
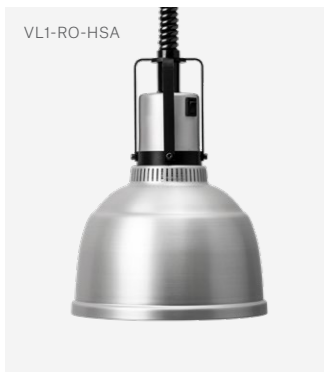
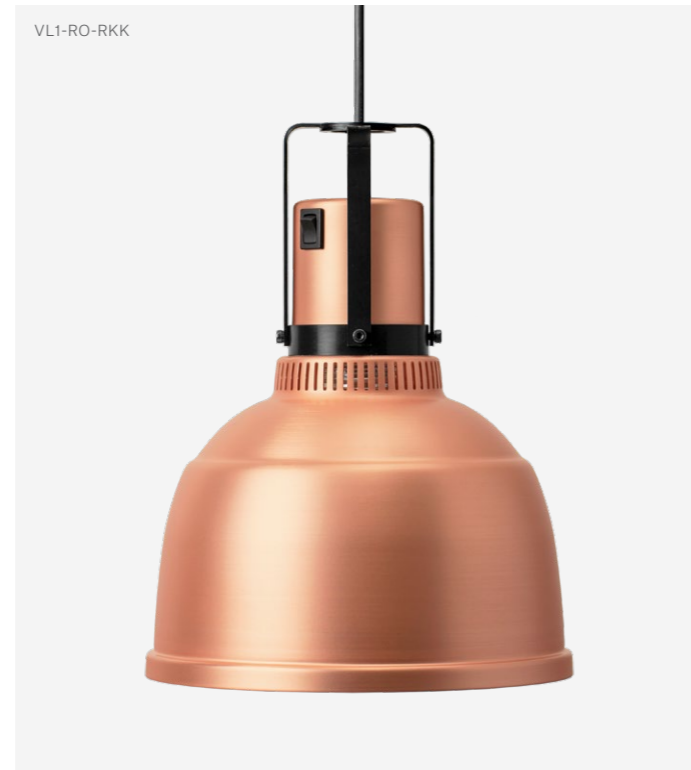

Heat Lamp Focus RO Retractable Cord

Shade	H 250 mm / Ø 220 mm
Rise & Fall	Min 850 mm / Max 2000 mm
Material	Anodised aluminium, galvanised steel
Heat Source	Philips infrared lamp, 2700K
Voltage / Power	230 V / 250 W

Article Number	Black	VL1-RO-HSS
	Aluminium	VL1-RO-HSA
	Copper	VL1-RO-HSK

Price 375 €

Heat Lamp Focus RO Standard Cord

Shade	H 250 mm / Ø 220 mm
Cord Length	2000 mm
Material	Anodised aluminium, galvanised steel
Heat Source	Philips infrared lamp, 2700K
Voltage / Power	230 V / 250 W

Article Number	Black	VL1-RO-RKS
	Aluminium	VL1-RO-RKA
	Copper	VL1-RO-RKK

Price 375 €



The RS model is
a modern take
on the classic
industrial lamp.



Heat Lamp Focus Model RS

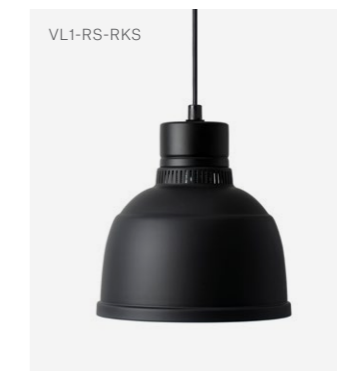
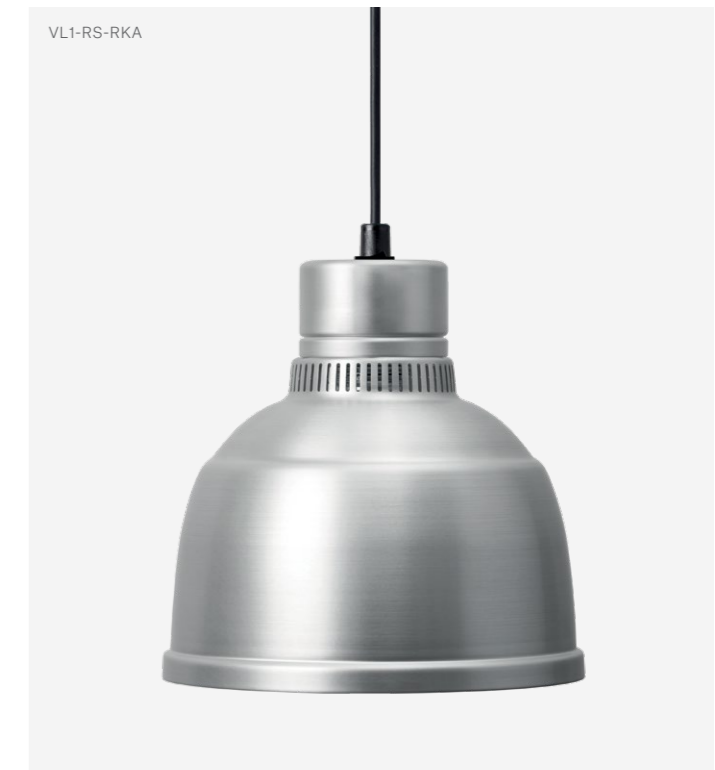

Heat Lamp Focus RS Retractable Cord

Shade	H 220 mm / Ø 220 mm	
Rise & Fall	Min 850 mm / Max 2000 mm	
Material	Aluminium	
Heat Source	Philips infrared lamp, 2700K	
Voltage / Power	230 V / 250 W	

Article Number	Black	VL1-RS-HSS
	Aluminium	VL1-RS-HSA

Price 375 €

Heat Lamp Focus RS Standard Cord

Shade	H 220 mm / Ø 220 mm	
Cord Length	2000 mm	
Material	Aluminium	
Heat Source	Philips infrared lamp, 2700K	
Voltage / Power	230 V / 250 W	

Article Number	Black	VL1-RS-RKS
	Aluminium	VL1-RS-RKA

Price 375 €

Heat Lamp Focus Model MO

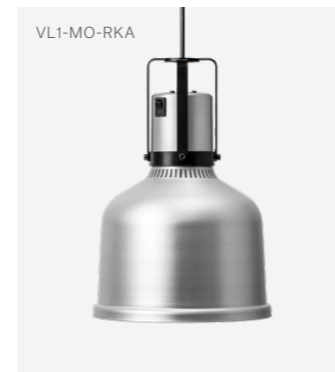
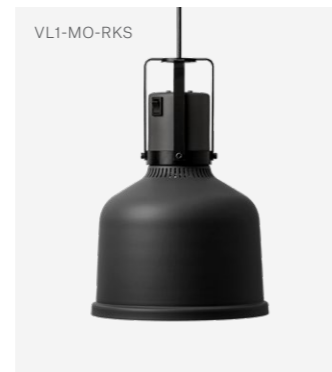
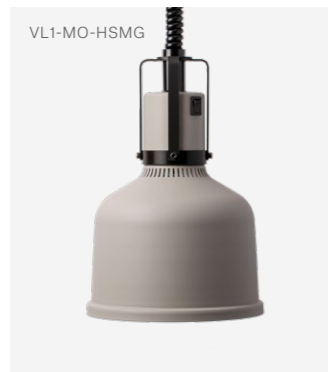
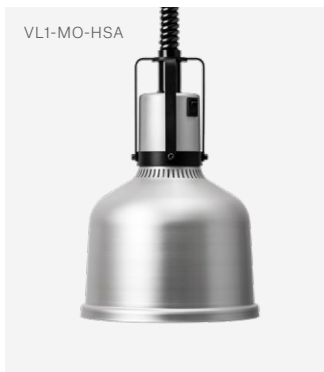

Heat Lamp Focus MO Retractable Cord

Shade	H 250 mm / Ø 200 mm
Rise & Fall	Min 850 mm / Max 2000 mm
Material	Anodised aluminium, galvanised steel
Heat Source	Philips infrared lamp, 2700K
Voltage / Power	230 V / 250 W

Article Number	Black	VL1-MO-HSS
	Aluminium	VL1-MO-HSA
	Mid Grey	VL1-MO-HSMG

Price 375 €

Heat Lamp Focus MO Standard Cord

Shade	H 250 mm / Ø 200 mm
Cord Length	2000 mm
Material	Anodised aluminium, galvanised steel
Heat Source	Philips infrared lamp, 2700K
Voltage / Power	230 V / 250 W

Article Number	Black	VL1-MO-RKS
	Aluminium	VL1-MO-RKA
	Mid Grey	VL1-MO-RKMG

Price 375 €

All prices in Euros (€) excluding VAT & shipping costs.



↑ Model VL1-MO-HSS
Restaurant Buen Cibo, Gothenburg

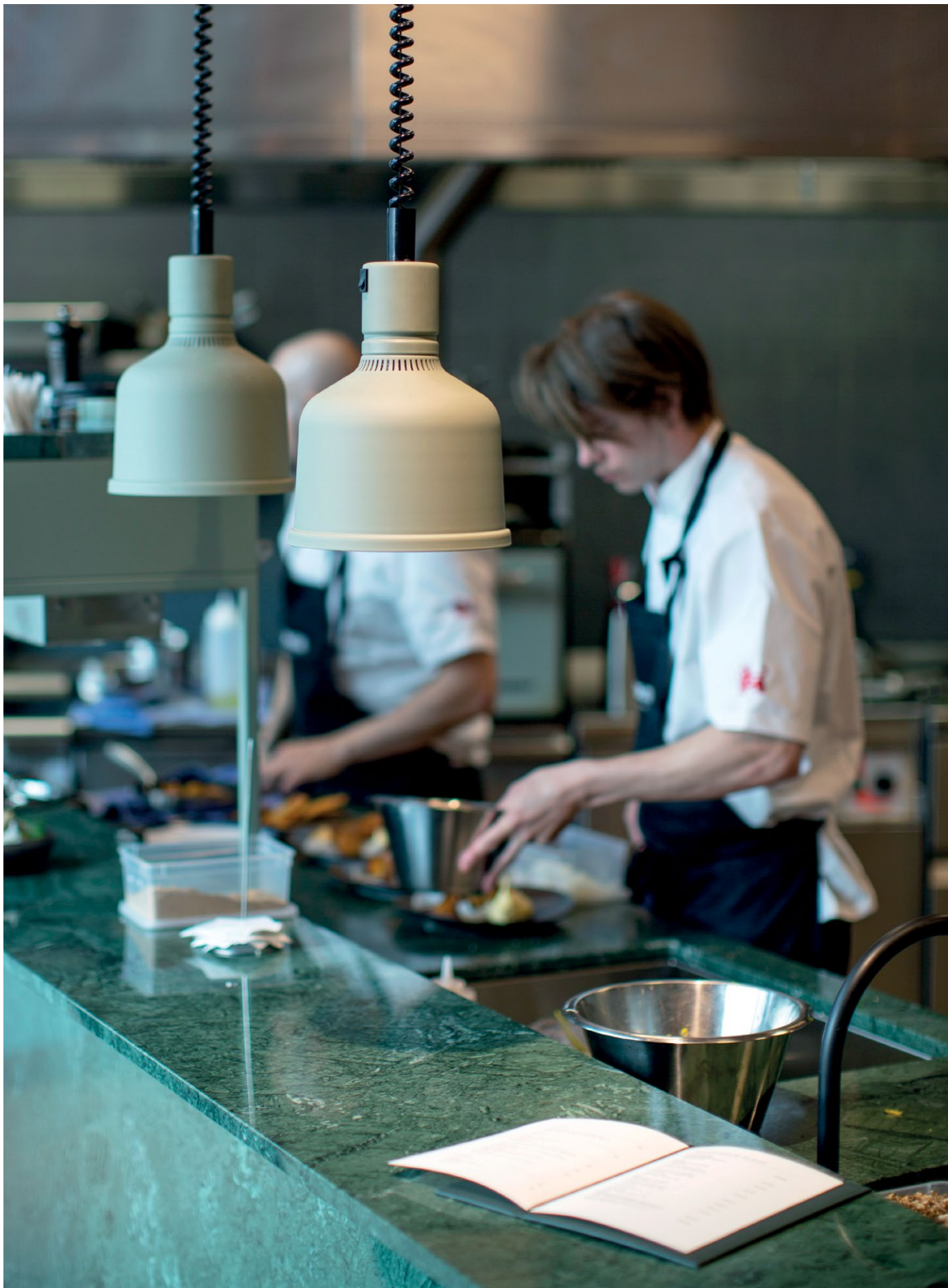

↑ Model VL1-MS-HSCG
Restaurant Norobata / Grow Hotel

Heat Lamp Focus Model MS

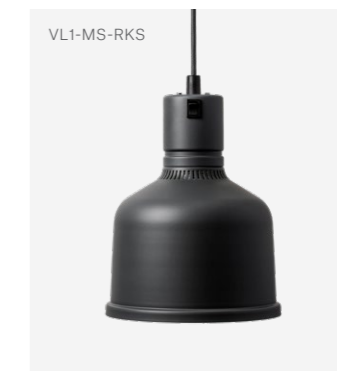
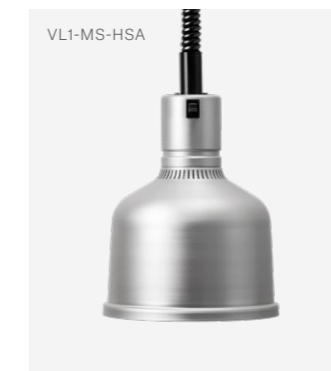
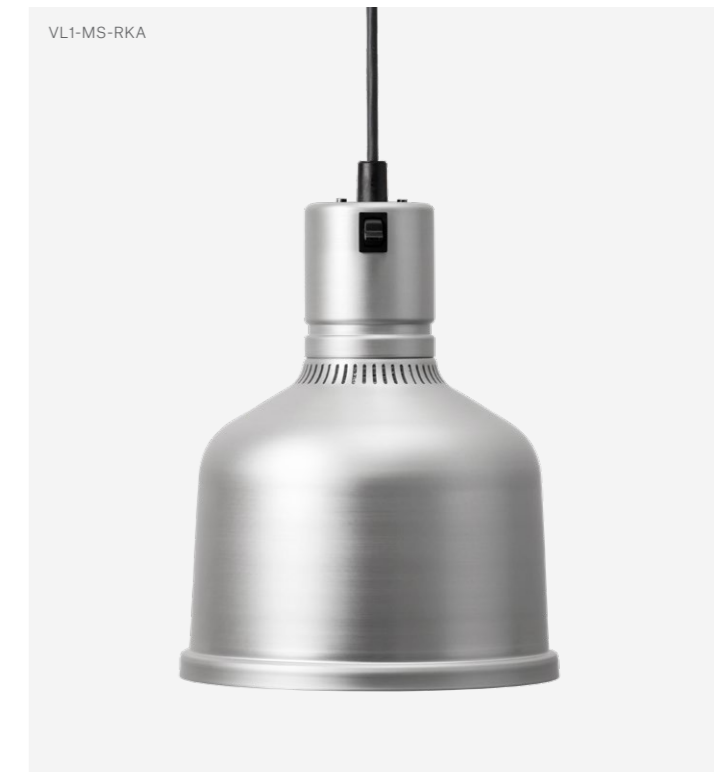
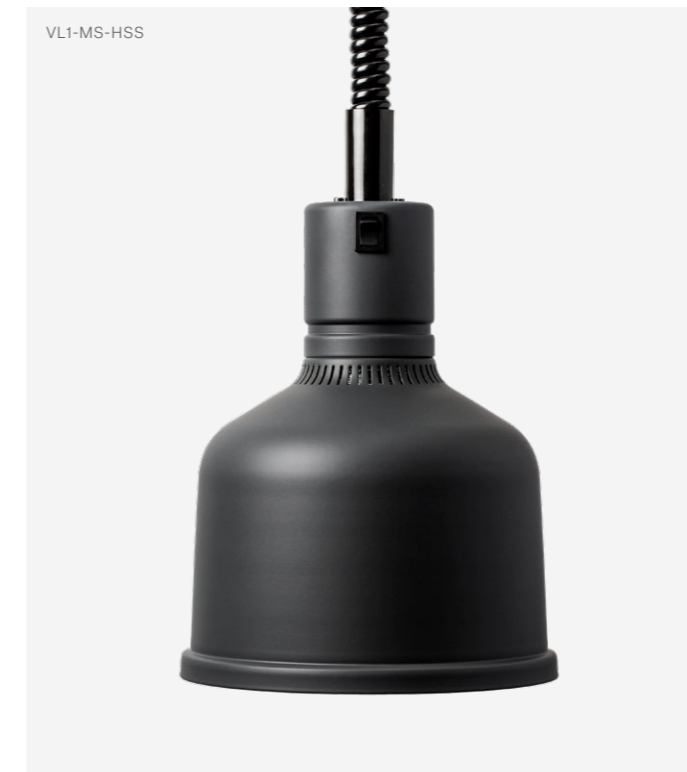

Heat Lamp Focus MS Retractable Cord

Shade	H 250 mm / Ø 200 mm
Rise & Fall	Min 850 mm / Max 2000 mm
Material	Anodised aluminium
Heat Source	Philips infrared lamp, 2700K
Voltage / Power	230 V / 250 W

Article Number	Black	VL1-MS-HSS
	Aluminium	VL1-MS-HSA
	Cement Grey	VL1-MS-HSCG

Price 375 €

Heat Lamp Focus MS Standard Cord

Shade	H 250 mm / Ø 200 mm
Cord Length	2000 mm
Material	Aluminium
Heat Source	Philips infrared lamp, 2700K
Voltage / Power	230 V / 250 W

Article Number	Black	VL1-MS-RKS
	Aluminium	VL1-MS-RKA
	Cement Grey	VL1-MS-RKCG

Price 375 €

Heat Lamp Focus Model IO

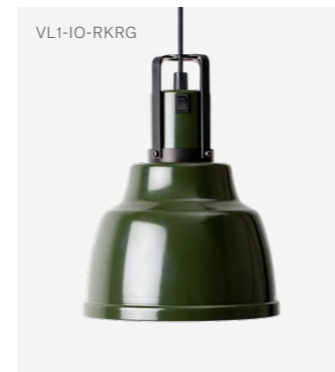
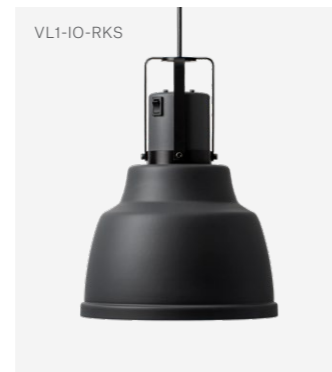
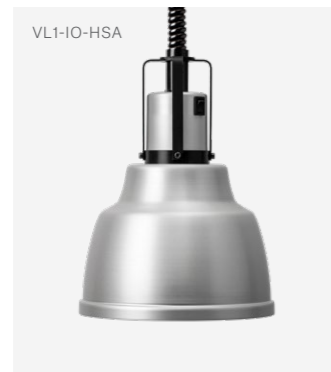
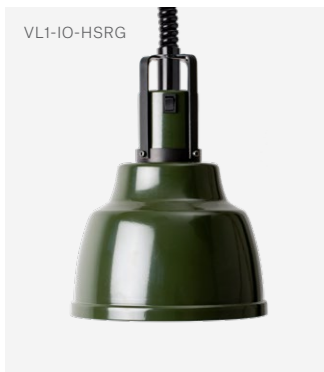
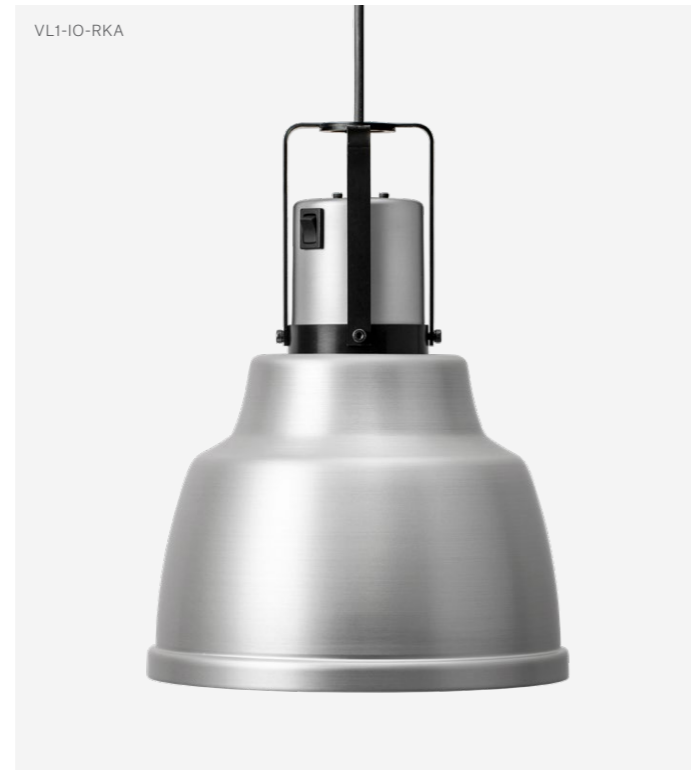

Heat Lamp Focus IO Retractable Cord

Shade	H 250 mm / Ø 220 mm
Rise & Fall	Min 850 mm / Max 2000 mm
Material	Anodised aluminium, galvanised steel
Heat Source	Philips infrared lamp, 2700K
Voltage / Power	230 V / 250 W

Article Number	Black	VL1-IO-HSS
	Aluminium	VL1-IO-HSA
	Racing Green	VL1-IO-HSRG

Price 375 €

Heat Lamp Focus IO Standard Cord

Shade	H 250 mm / Ø 220 mm
Cord Length	2000 mm
Material	Anodised aluminium, galvanised steel
Heat Source	Philips infrared lamp, 2700K
Voltage / Power	230 V / 250 W

Article Number	Black	VL1-IO-RKS
	Aluminium	VL1-IO-RKA
	Racing Green	VL1-IO-RKRG

Price 375 €





1B

Heat Lamp Classic

Restaurant Mine Wine Berlin
Photo: Mine Wine Berlin
↑

*Heat Lamp Classic
— in the heart of
the kitchen.*

Stayhot Heat Lamp Classic offers timeless design combined with unmatched performance; the perfect choice for the demanding restaurant. ——— Using only components of the highest quality, these heat lamps are manufactured with precision at our warehouse in Sollentuna, Sweden. ——— Choose with or without retractable cord mounting. Available in six standard colours; aluminium, brass, copper, black, chrome and black lacquer.

Heat Lamp Classic Model 1224

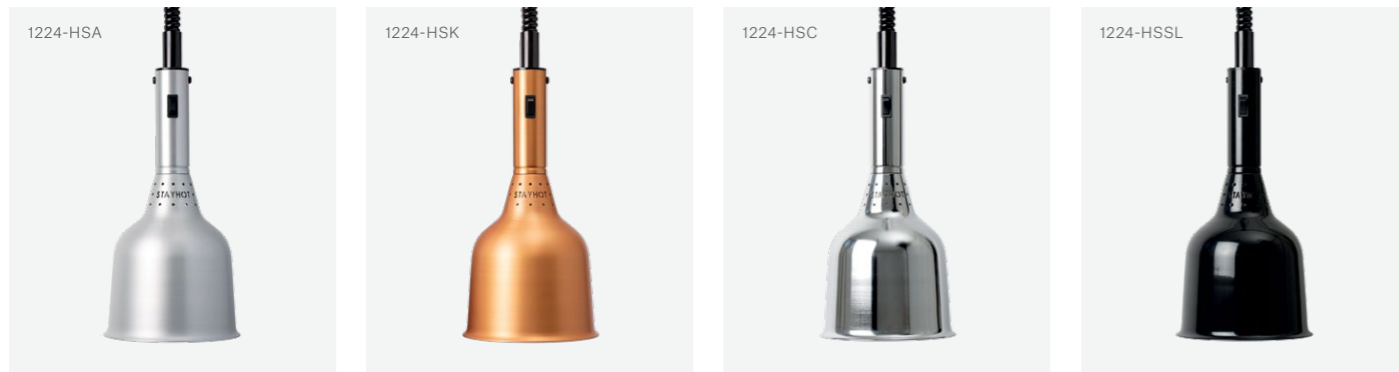
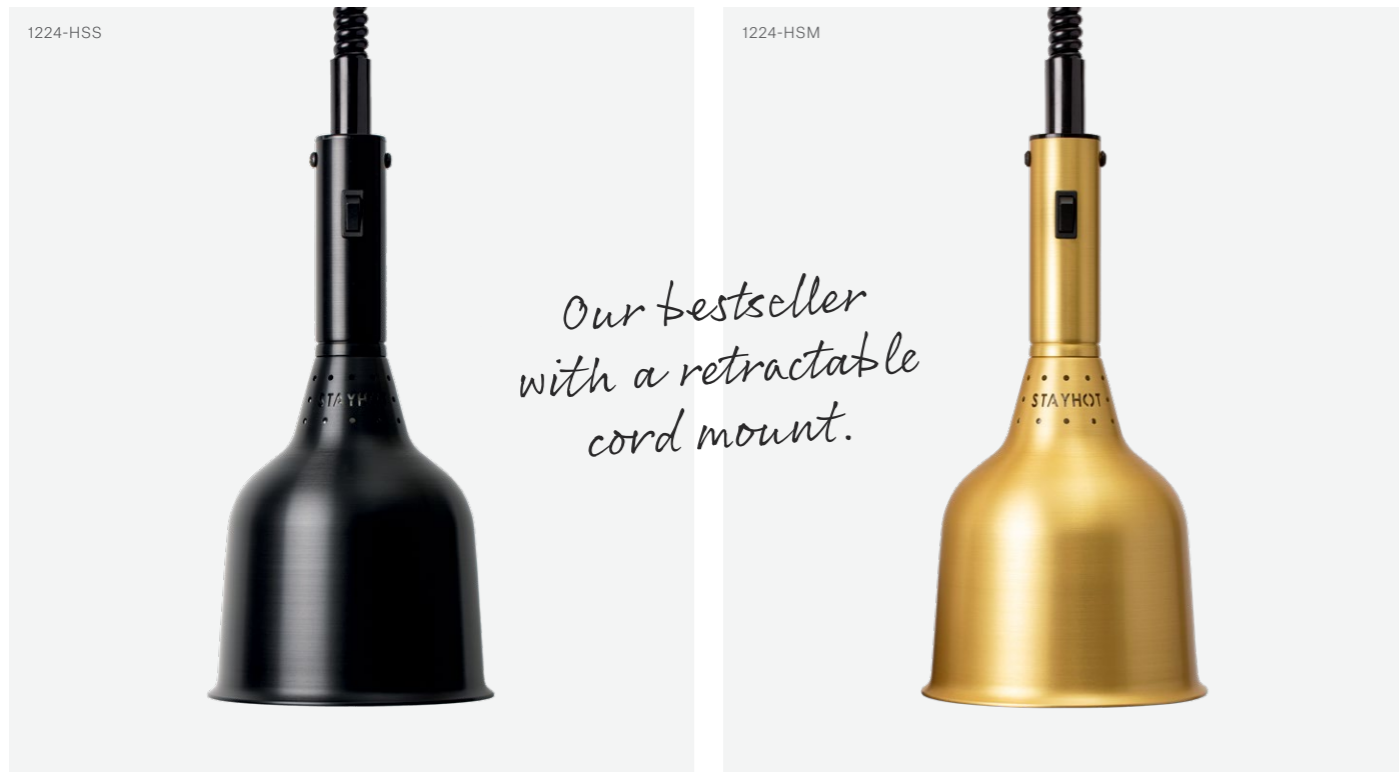

Heat Lamp Classic 1224 Retractable Cord

Stayhot Classic Heat Lamp 1224 is manufactured using anodised aluminium and comes with a retractable cord mount, which enables you to easily adjust the height of the heat lamp when needed.

Shade	H 350 mm / Ø 180 mm
Rise & Fall	Min 950 mm / Max 2100 mm
Material	Anodised aluminium
Heat Source	Philips infrared lamp, 2700K
Voltage / Power	230 V / 250 W
Installation	25-45 cm above food

Article Number	Black	1224-HSS
	Brass	1224-HSM
	Aluminium	1224-HSA
	Copper	1224-HSK
	Chrome	1224-HSC
	Black Lacquer	1224-HSSL

Price 299 €

Heat Lamp Classic Model 1223



Heat Lamp Classic 1223 Standard Cord

Stayhot Classic Heat Lamp 1223 is manufactured using high quality anodised aluminium and comes with a ceiling mount, heat resistant cable and power switch.

Shade	H 350 mm / Ø 180 mm
Cord Length	2000 mm
Material	Anodised aluminium
Heat Source	Philips infrared lamp, 2700K
Voltage / Power	230 V / 250 W
Installation	25-45 cm above food

Article Number	Black	1223-S
	Brass	1223-M
	Aluminium	1223-A
	Copper	1223-K
	Chrome	1223-C
	Black Lacquer	1223-SL

Price 299 €

Heat Lamp Classic Model 1222

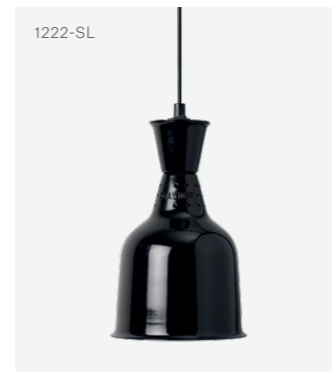
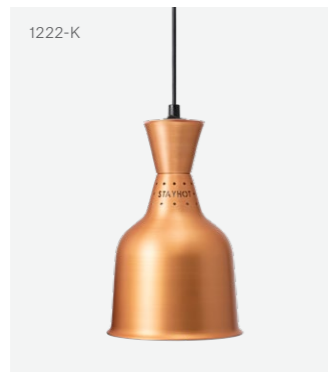

Heat Lamp Classic 1222 Standard Cord

Stayhot Classic Heat Lamp 1222 is manufactured using high quality anodised aluminium and comes with a ceiling mount, heat resistant cable and power switch.

Shade	H 290 mm / Ø 180 mm
Cord Length	2000 mm
Material	Anodised aluminium
Heat Source	Philips infrared lamp, 2700K
Voltage / Power	230 V / 250 W
Installation	25-45 cm above food

Article Number	Black	1222-S
	Brass	1222-M
	Aluminium	1222-A
	Copper	1222-K
	Black Lacquer	1222-SL

Price 269 €

Heat Lamp Classic Model 1250

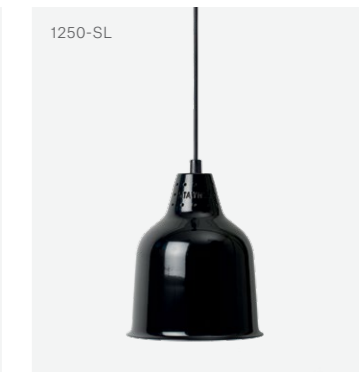
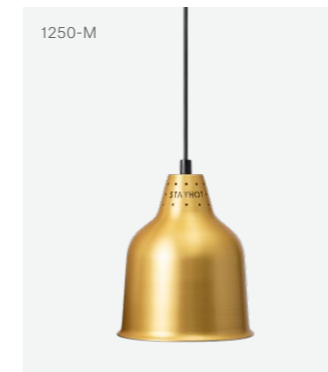
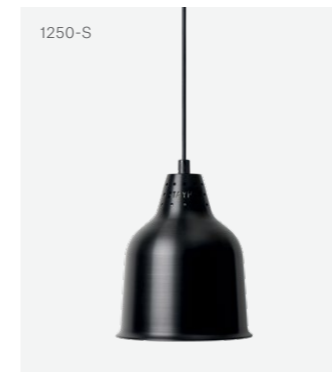
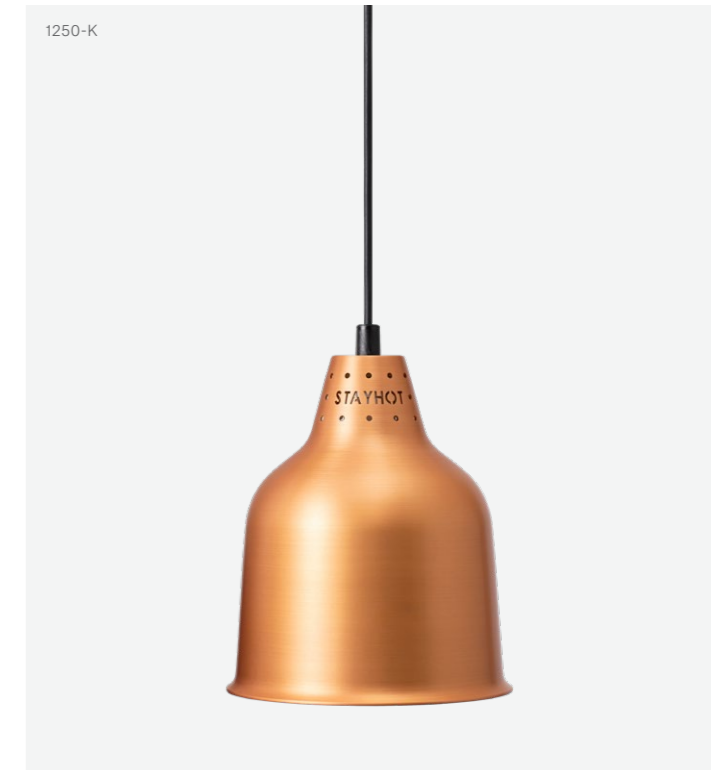

Heat Lamp Classic 1250 Standard Cord

Stayhot Classic Heat Lamp 1250 is manufactured using high quality anodised aluminium and comes with a ceiling mount and heat resistant cable.

Shade	H 220 mm / Ø 180 mm
Cord Length	2000 mm
Material	Anodised aluminium
Heat Source	Philips infrared lamp, 2700K
Voltage / Power	230 V / 250 W
Installation	25-45 cm above food

Article Number	Black	1250-S
	Brass	1250-M
	Aluminium	1250-A
	Copper	1250-K
	Chrome	1250-C
	Black Lacquer	1250-SL

Price 188 €

Heat Lamp Trattoria Model 1224

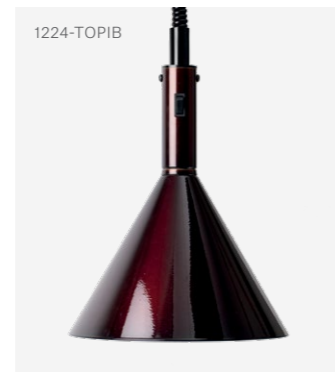
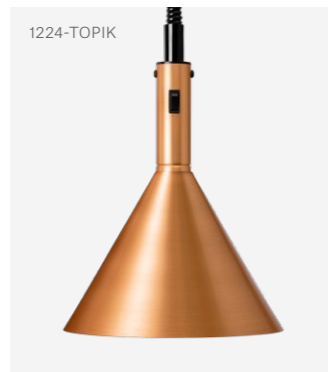

Värmelampa Trattoria 1224 Hissfunktion

Heat Lamp Trattoria offers a timeless shape that complements most restaurant interiors. Manufactured using anodised aluminium, this heat lamp comes with a retractable cord mount, which enables you to easily adjust the height of the heat lamp when needed.

Article Number	Black	1224-TOPIS
	Brass	1224-TOPIM
	Aluminium	1224-TOPIA
	Copper	1224-TOPIK
	Bronze	1224-TOPIB

Shade	H 330 mm / Ø 280 mm
Rise & Fall	Min 950 mm / Max 2100 mm
Material	Anodised aluminium
Heat Source	Philips infrared lamp, 2700K
Voltage / Power	230 V / 250 W

Price **324 €**



Heat Lamp Trattoria Model 1223

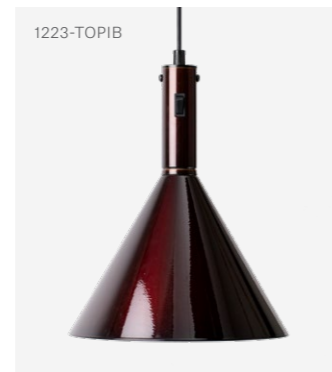
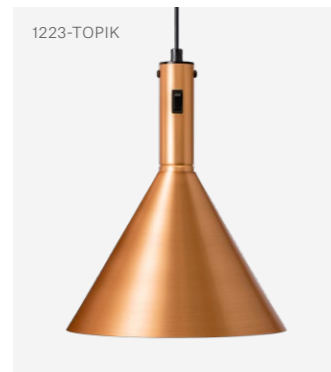

Heat Lamp Trattoria 1223 Standard Cord

Heat Lamp Trattoria offers a timeless shape that complements most restaurant interiors. Manufactured using high quality anodised aluminium and comes with a ceiling mount, heat resistant cable and power switch.

Article Number	Black	1223-TOPIS
	Brass	1223-TOPIM
	Aluminium	1223-TOPIA
	Copper	1223-TOPIK
	Bronze	1223-TOPIB

Shade	H 330 mm / Ø 280 mm
Cord Length	2000 mm
Material	Anodised aluminium
Heat Source	Philips infrared lamp, 2700K
Voltage / Power	230 V / 250 W

Price 324 €

Heat Lamp Trattoria Model 1250

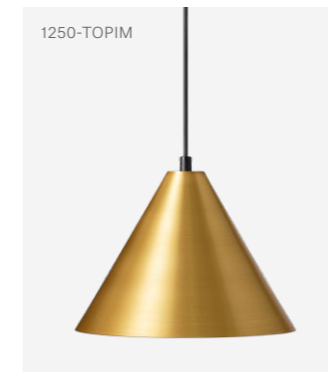
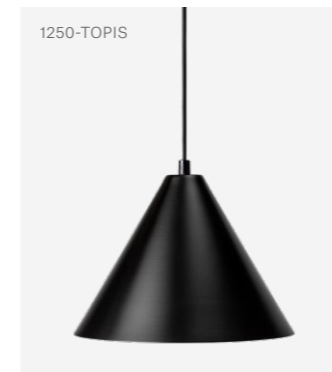

Heat Lamp Trattoria 1250 Standard Cord

Heat Lamp Trattoria offers a timeless shape that complements most restaurant interiors. Manufactured using high quality anodised aluminium and comes with a ceiling mount and heat resistant cable.

Artikelnummer	Black	1250-TOPIS
	Brass	1250-TOPIM
	Aluminium	1250-TOPIA
	Copper	1250-TOPIK
	Bronze	1250-TOPIB

Shade	H 200 mm / Ø 280 mm
Cord Length	2000 mm
Material	Anodised aluminium
Heat Source	Philips infrared lamp, 2700K
Voltage / Power	230 V / 250 W

Price 224 €



The Lamp Factory

Create unique, customised heat lamps that suit your specific project or colour palette.

- Choose any RAL colour (226 in total)
- Available in both matte and glossy finish
- Initial cost 99 € and then 25 € for each heat lamp*



* Customisation costs to be added on top of prices for each heat lamp.

At The Lamp Factory, you can easily customise our heat lamps to suit your specific needs for a particular restaurant environment or colour scheme. ————— We can customise all our Classic and Focus heat lamps. Choose from 226 RAL colours and between matte and glossy finish. ————— Do not hesitate to get in touch for more information.



Heat Lamp Exclusive Model 22001

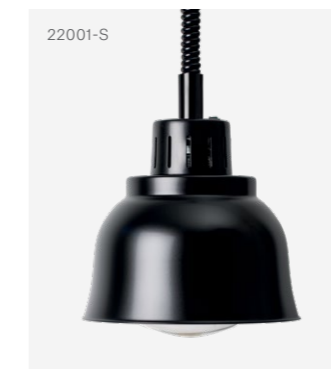
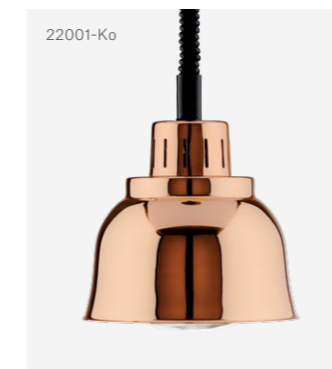
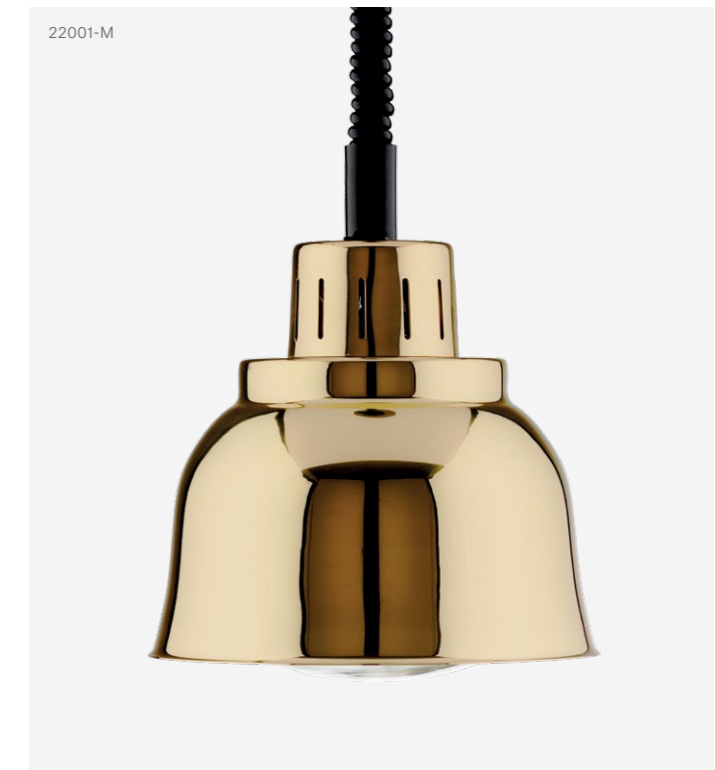
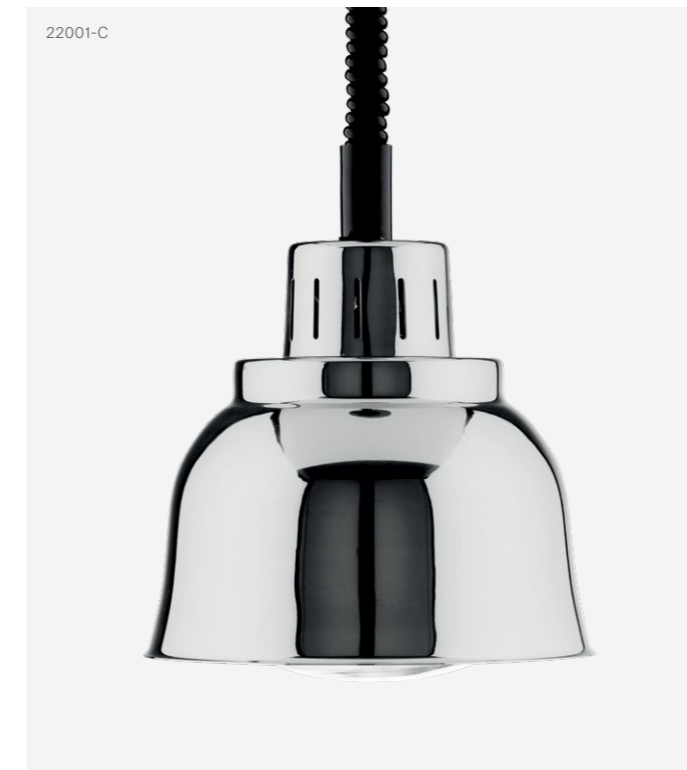

Exclusive and elegant design.

Heat Lamp Exclusive 22001 Retractable Cord

Heat Lamp Exclusive 22001 offers a timeless and elegant food warming option that fits well into most restaurant environments. This specific model is available in four standard finishes and comes with a retractable cord mount.

Article Number	Chrome	22001-C
	Brass	22001-M
	Copper	22001-K
	Black	22001-S

Shade	H 220 mm / Ø 225 mm
Rise & Fall	Min 850 mm / Max 2000 mm
Material	Steel
Heat Source	Philips infrared lamp, 2700K
Voltage / Power	230 V / 250 W
Installation	25-45 cm above food

Price 427 €

Heat Lamp Exclusive Model 23001

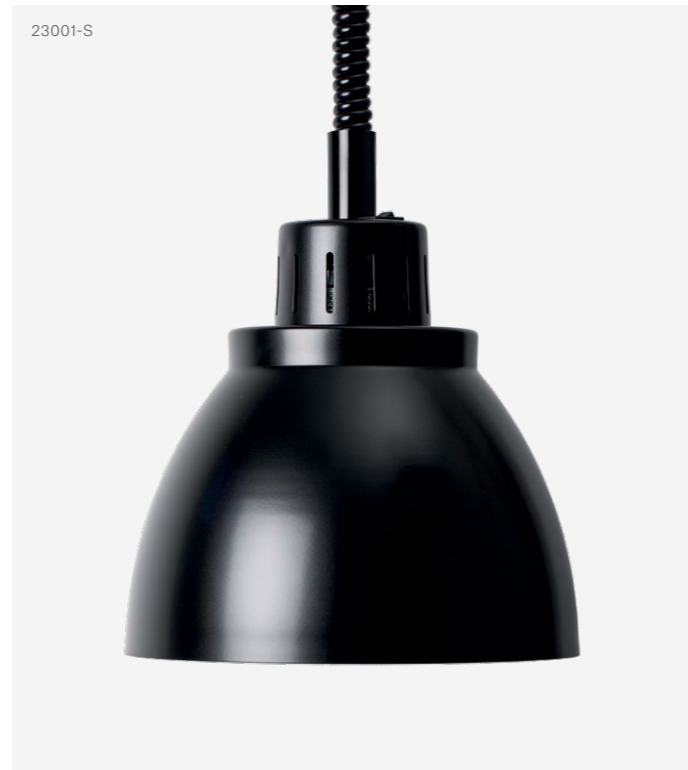

*Timeless design meets
unbeatable quality.
Made in Germany.*

Heat Lamp Exclusive 23001 Retractable Cord

Heat Lamp Exclusive 23001 offers a timeless and elegant food warming option that fits well into most restaurant environments. This specific model is available in two standard finishes and comes with a retractable cord mount.

Article Number	Chrome	23001-C
	Black	23001-S

Price 429 €

Shade	H 250 mm / Ø 240 mm
Rise & Fall	Min 850 mm / Max 2000 mm
Material	Steel
Heat Source	Philips infrared lamp, 2700K
Voltage / Power	230 V / 250 W
Installation	25-45 cm above food

Heat Lamp Compact Model 27001

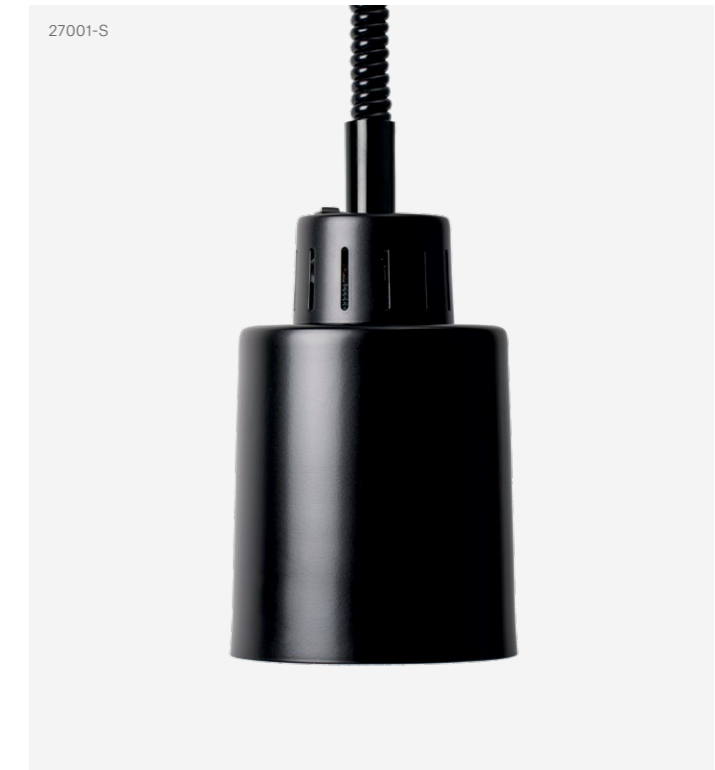

*Minimal
design.*

Heat Lamp Compact 27001 Retractable Cord

Heat Lamp Compact 27001 offers a modern alternative that fits well into most restaurant environments. This specific model is available in four standard finishes and comes with a retractable cord mount.

Article Number	Bronze	27001-B
	Black	27001-S
	White	27001-V
	Aluminium	27001-A

Price 324 €

Shade	H 220 mm / Ø 140 mm
Rise & Fall	Min 850 mm / Max 2000 mm
Material	Steel
Heat Source	Philips infrared lamp, 2700K
Voltage / Power	230 V / 250 W
Installation	25-45 cm above food



Freestanding Heat Lamp Focus LPF

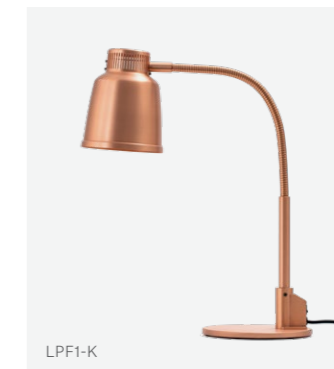

Freestanding Heat Lamp Focus Model LPF

Freestanding Heat Lamp Focus LPF is the latest addition to our product family. Designed, developed and manufactured by us in Sollentuna. These heat lamps offer an elegant and flexible warming alternative to the buffet table. Available in six standard colours.

Height	635 mm
Shade	H 218 / Ø 180 mm
Base	Ø 236 x 12 mm
Heat Source	Philips infrared lamp, 2700K
Voltage / Power	230 V / 250 W

Article Number	Cement Grey	LPF1-CG
	Black	LPF1-S
	White	LPF1-V
Price	539 €	

Article Number	Brass	LPF1-M
	Copper	LPF1-K
	Stainless Steel	LPF1-RF
Price	619 €	



← Ludwig Tjörnemo
Guld medallist
2020 Swedish Chef of the Year

Freestanding Heat Lamp Focus LPF / Clamp Base

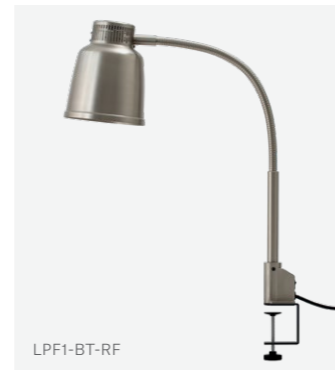
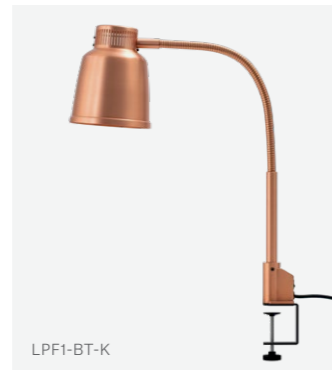
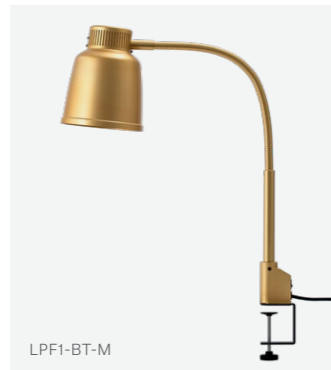

Freestanding Heat Lamp Focus Model LPF with Clamp Base

Our new freestanding heat lamp Focus LPF is also available with a clamp base for table mounting. Perfect when space is scarce. Designed, developed and manufactured by us in Sollentuna. Available in six different colours.

Height	635 mm
Shade	H 218 / Ø 180 mm
Table Clamp	95 x 60 x 78 mm
Heat Source	Philips infrared lamp, 2700K
Voltage / Power	230 V / 250 W

Article Number	Cement Grey	LPF1-BT-CG
	Black	LPF1-BT-S
	White	LPF1-BT-V
Price	519 €	

Article Number	Brass	LPF1-BT-M
	Copper	LPF1-BT-K
	Stainless Steel	LPF1-BT-RF
Price	599 €	

All prices in Euros (€) excluding VAT & shipping costs.





↑ Marcus Bremdahl
Finalist, 2020 Swedish Chef of the Year



Freestanding Heat Lamp Exclusive

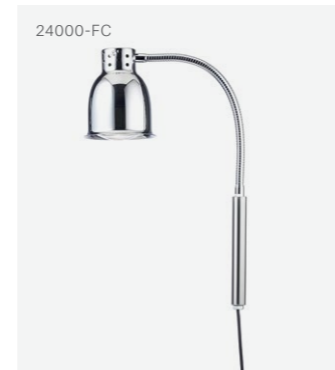
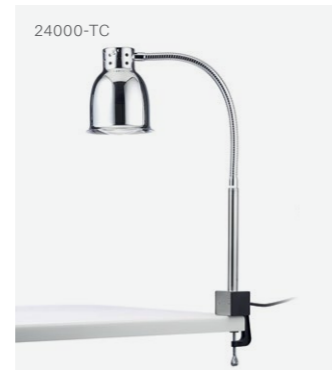
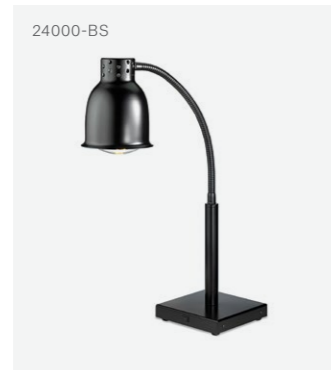

Freestanding Heat Lamp Exclusive Model 24000

This freestanding Heat Lamp Exclusive is the perfect option for anyone in need of an elegant, reliable and movable food warmer. Model 24000 has a power switch, stable base and flexible arm. Also available with table top mounting with a clamp as well as fixed mounting.

Height	700 mm
Shade	H 210 / Ø 180 mm
Base	200 x 200 x 40 mm
Voltage / Power	230 V / 250 W

Article Number	24000-BC	Chrome
	24000-BV	White
	24000-BS	Black

Price 548 €

Article Number	24000-BG	Brass
----------------	----------	-------

Price 625 €

Article Number	24000-TC	Table Top Mounting
	24000-FC	Fixed Mounting

Price 436 €

All prices in Euros (€) excluding VAT & shipping costs.

Freestanding Heat Lamp Exclusive / Double

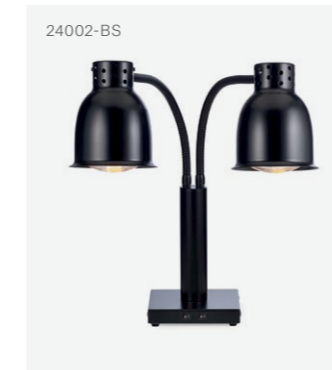
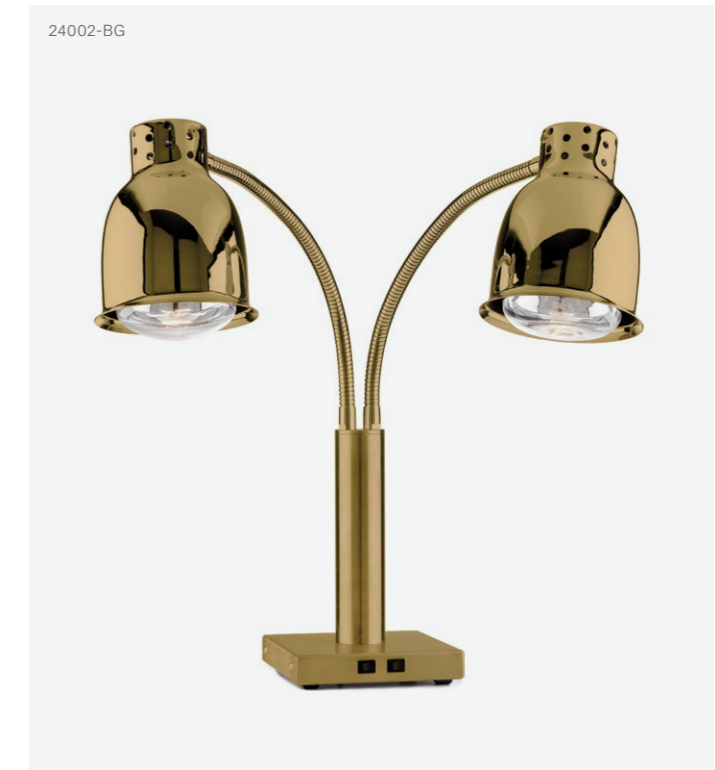

Freestanding Heat Lamp Exclusive Model 24002 / Double

This freestanding Heat Lamp Exclusive is the perfect option for anyone in need of an elegant, reliable and movable food warmer. Model 24002 offers twice the amount of heating with two separate flexible arms.

Height	700 mm
Shade	H 210 / Ø 180 mm
Base	200 x 200 x 40 mm
Voltage / Power	230 V / 2 x 250 W

Article Number	24002-BC	Chrome
	24002-BS	Black

Price 929 €

Article Number	24002-BG	Brass
----------------	----------	-------

Price 1018 €

*An elegant, functional
and flexible food warmer.*



*A reliable companion in
the restaurant kitchen.*

Over the years, our Stayhot strip heaters have been utilised as a trusted and reliable food warmer in restaurant kitchens all around Sweden and Europe. ————— These strip heaters are designed and manufactured by us in our Sollentuna warehouse using polished stainless steel and powerful infrared quartz heating elements. ————— Our strip heaters are space efficient and keep the food appetisingly hot. Choose from eight different models with or without separate lighting.

Strip Heater Classic Without Lights (V)



Strip Heater Classic Without Lights (V)

Our space efficient strip heaters are locally manufactured using stainless steel and powerful infrared quartz heating elements. Easy to install with our adjustable mounting plates.

Material	Stainless steel		Model	Strip Heater V-570
Heat Source	Infrared Quartz Element		Article Number	V-570
Installation	25-45 cm above food		Price	418 €
Voltage	230 V		Model	Strip Heater V-640
Power	V-570 / V-640	575 W	Article Number	V-640
	V-945	750 W	Price	448 €
	V-1250	1000 W	Model	Strip Heater V-945
Width	570 / 640 / 945 / 1250 mm		Article Number	V-945
Depth / Height	150 x 60 mm		Price	512 €
			Model	Strip Heater V-1250
			Article Number	V-1250
			Price	538 €

Strip Heater Classic With Lights (VL)

*Designed and
manufactured by us
in our warehouse.*

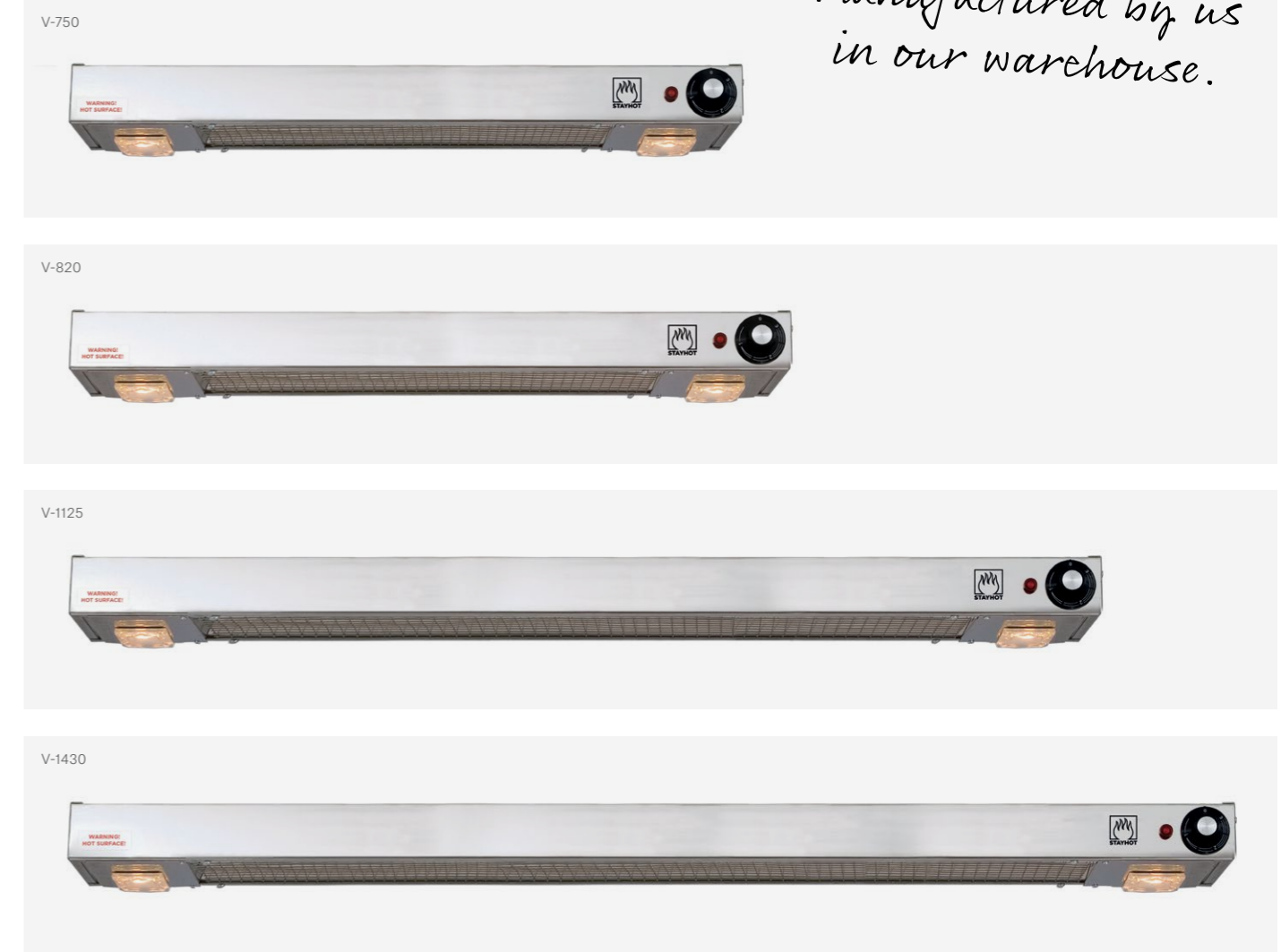

Strip Heater Classic With Lights (VL)

Our space efficient strip heaters are locally manufactured using stainless steel and powerful infrared quartz heating elements. Table stands or hanging chains are sold separately.

Material	Stainless steel		Model	Strip Heater VL-750
Heat Source	Infrared Quartz Element		Article Number	VL-750
Installation	25-45 cm above food		Price	499 €
Voltage	230 V		Model	Strip Heater VL-820
Power	VL-750 / VL-820	575 + 50 W	Article Number	VL-820
	VL-1125	750 + 50 W	Price	524 €
	VL-1430	1000 + 50 W	Model	Strip Heater VL-1125
Width	750 / 820 / 1125 / 1430 mm		Article Number	VL-1125
Depth / Height	150 x 60 mm		Price	579 €
			Model	Strip Heater VL-1430
			Article Number	VL-1430
			Price	608 €

Strip Heater Classic Freestanding Table Stands

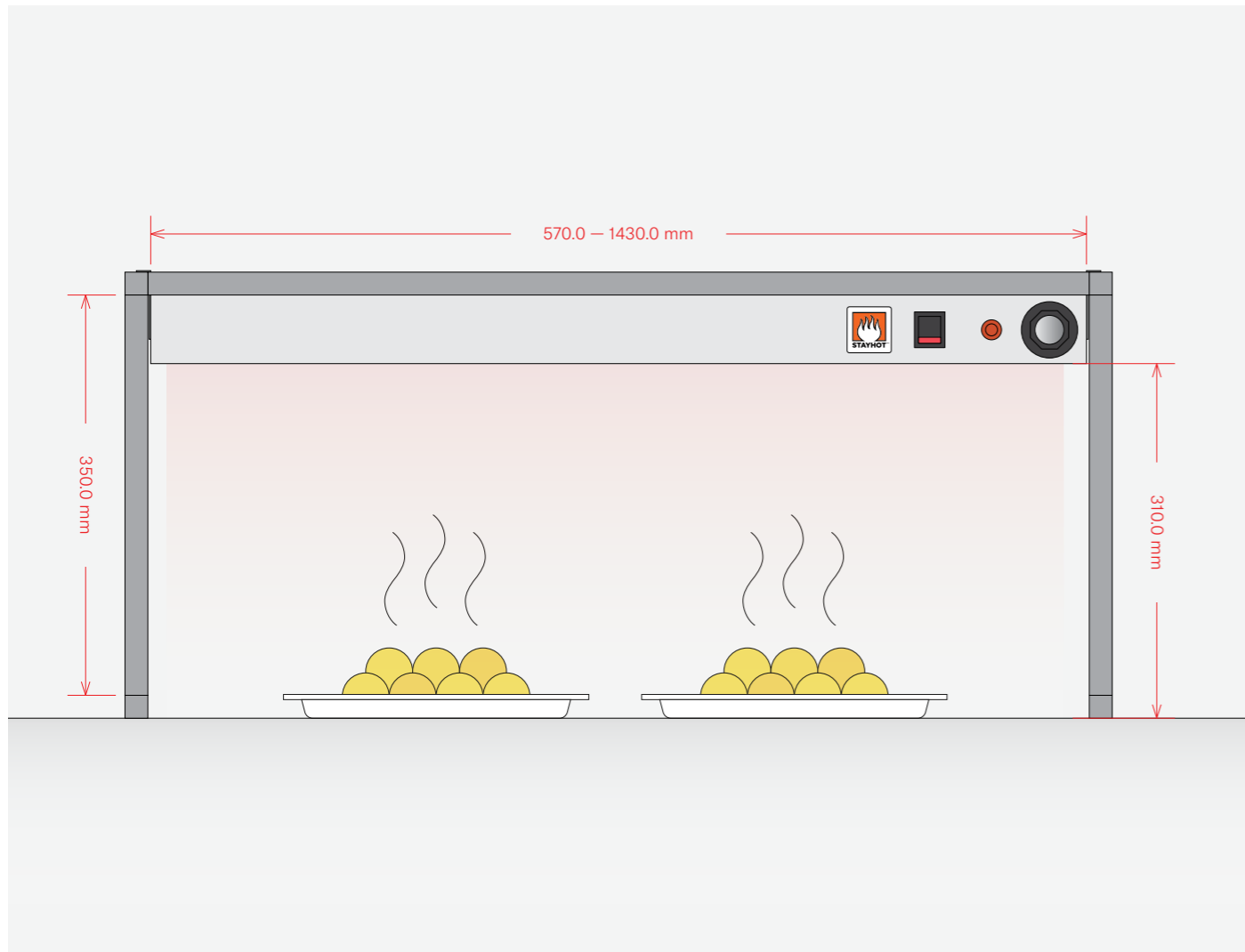

Strip Heater Classic Freestanding Table Stands

We offer table stands for our strip heaters. It's a flexible alternative for anyone who wants a freestanding solution for their strip heater instead of mounting it under a shelf. Manufactured using high quality stainless steel tubes, all stands include a sheet of tempered glass to be used as shelf space. Our stands are easy to bring out when needed, say for a breakfast or lunch buffet, and can just as easily be tucked away when not needed.

All prices include a shelf made of 8 mm tempered glass. If a customer wishes to order a stand without glass, the total price will be deducted € 35 - 50 depending on the strip heater model.

Model Stand for Strip Heater V-570
Article Number FS-570
Measurements 615 x 195 x 390 (mm)
Price 325 €

Model Stand for Strip Heater V-640
Article Number FS-640
Measurements 685 x 195 x 390 (mm)
Price 335 €

Model Stand for Strip Heater V-945
Article Number FS-945
Measurements 990 x 195 x 390 (mm)
Price 355€

*Our table stands offer
a freestanding food
warming solution.*

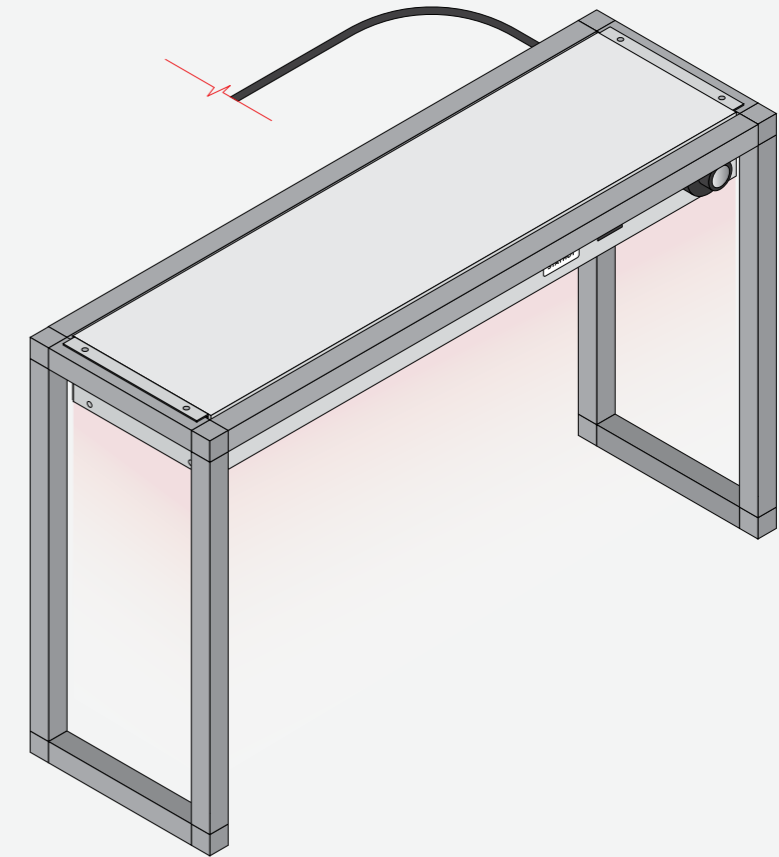

Model Stand for Strip Heater V-1250
Article Number FS-1250
Measurements 1295 x 195 x 390 (mm)
Price 375 €

Model Stand for Strip Heater VL-750
Article Number FS-750
Measurements 795 x 195 x 390 (mm)
Price 339 €

Model Stand for Strip Heater VL-820
Article Number FS-820
Measurements 865 x 195 x 390 (mm)
Price 345 €

Model Stand for Strip Heater VL-1125
Article Number FS-1125
Measurements 1170 x 195 x 390 (mm)
Price 365 €

Model Stand for Strip Heater VL-1430
Article Number FS-1430
Measurements 1475 x 195 x 390 (mm)
Price 385 €

Hot Trays



Stayhot Hot Tray WP 250

Material	Ceramic glass
Dimensions	640 x 340 x 40 mm
Voltage / Power	230 V / 250 W
Heated Surface	530 x 325 mm
Article Number	WP-250
Price	322 €



Stayhot Hot Tray WP 305 RE

Material	Ceramic glass
Dimensions	640 x 340 x 40 mm
Voltage / Power	230 V / 300 W
Heated Surface	530 x 325 mm
Article Number	WP-305-RE
Price	359 €



Stayhot Hot Tray WP 350

Material	Ceramic glass
Dimensions	720 x 425 x 40 mm
Voltage / Power	230 V / 350 W
Heated Surface	620 x 420 mm
Article Number	WP-350
Price	366 €



Stayhot Hot Tray WP 405 RE

Material	Ceramic glass
Dimensions	720 x 425 x 40 mm
Voltage / Power	230 V / 400 W
Heated Surface	620 x 420 mm
Article Number	WP-405-RE
Price	414 €



Stayhot Hot Tray WPS 857

Material	Stainless steel
Dimensions	505 x 200 x 45 mm
Voltage / Power	230 V / 850 W
Article Number	WPS-857
Price	99 €



Stayhot Hot Tray WPE 307 / Built-in version

Material	Ceramic glass
Dimensions	570 x 365 x 45 mm
Voltage / Power	230 V / 300 W
Heated Surface	530 x 325 mm
Article Number	WPE-307
Price	608 €

Our high quality hot trays are a great addition to any restaurant buffet. Using durable ceramic glass, our hot trays are functional, elegant & affordable.

Soup Heaters



Stayhot Soup Warmer / Exclusive Black

Dimensions	H 350 mm / Ø 250 mm
Voltage / Power	230 V / 300 W
Volume	5,1 L
Weight	7 kg
Article Number	BL-402
Price	475 €



Stayhot Soup Warmer / Exclusive Bronze

Dimensions	H 350 mm / Ø 250 mm
Voltage / Power	230 V / 300 W
Volume	5,1 L
Weight	7 kg
Article Number	BR-403
Price	475 €



Stayhot Soup Warmer / Hot Soup 405

Dimensions	H 350 mm / Ø 250 mm
Voltage / Power	230 V / 300 W
Volume	5,1 L
Weight	7 kg
Article Number	SCR-405
Price	475 €



Stayhot Soup Warmer / Built-in Version

Dimensions	H 350 mm / Ø 250 mm
Cut-out Dimensions	Ø 260 mm
Voltage / Power	230 V / 300 W
Volume	5,1 L
Weight	7 kg
Article Number	SCV-Silver
Price	402 €

Sometimes you just need to keep cool & calm. For these moments, we can offer our Staychill Chill Trays, available in five Gastronorm sizes as well as a round model. They will keep your food appetisingly fresh & most importantly, cold.



*Our chill trays make
sure the buffet stays
appetisingly cold.*

Whether for the breakfast or salad buffet, Staychill is the effective solution for keeping the food cold. ————— Our elegant and affordable chill trays keep everything from juice to butter cold, whilst being an excellent helper for holiday buffets, catering event as well as any smorgasbord. ————— Choose between five gastronom sizes as well as our round model.

Staychill Chill Trays



Staychill Chill Tray GN 1/1

Dimensions	530 x 325 x 36 (mm)
Material	Aluminium
Article Number	SCSL1
Price	77 €



Staychill Chill Tray GN 1/2

Dimensions	325 x 265 x 36 (mm)
Material	Aluminium
Article Number	SCSL2
Price	56 €



Staychill Chill Tray GN 1/3

Dimensions	325 x 176 x 36 (mm)
Material	Aluminium
Article Number	SCSL3
Price	50 €



Staychill Chill Tray GN 1/4

Dimensions	265 x 162 x 36 (mm)
Material	Aluminium
Article Number	SCSL4
Price	46 €



Staychill Chill Tray GN 1/6

Dimensions	176 x 162 x 36 mm
Material	Aluminium
Article Number	SCSL6
Price	39 €



Staychill Chill Tray Round

Dimensions	Ø 300 x 30 mm
Material	Aluminium
Article Number	SCSLR
Price	67 €

Store the chill tray in the freezer* for twelve hours. The temperature of the chill tray is then kept below +8 °C for at least three hours**.

* at -18 °C or colder

** at a +22 °C room temperature



STAYCHILL BRASS COVERS

Keep cool in style with our new Staychill brass covers.

Brass Covers for Staychill Chill Trays



Brass Cover Staychill Chill Tray GN 1/1

Add a unmatched elegance to your breakfast buffet with our brass covers. Made to order. Allow for approximately 3 weeks delivery time.

Measurements	530 x 325 x 36 (mm)
Material	Brass
Article Number	SCBC-1
Price	280 €



Brass Cover Staychill Chill Tray GN 1/2

Elegant brass covers for our Staychill Chill Trays. Made in Sweden. Made to order. Allow for approximately 3 weeks delivery time.

Measurements	325 x 265 x 36 (mm)
Material	Brass
Article Number	SCBC-2
Price	220 €



Brass Cover Staychill Chill Tray GN 1/3

Elegant brass covers for our Staychill Chill Trays. Made in Sweden. Made to order. Allow for approximately 3 weeks delivery time.

Measurements	325 x 176 x 36 (mm)
Material	Brass
Article Number	SCBC-3
Price	180 €



Brass Cover Staychill Chill Tray GN 1/4

Elegant brass covers for our Staychill Chill Trays. Made in Sweden. Made to order. Allow for approximately 3 weeks delivery time.

Measurements	265 x 162 x 36 (mm)
Material	Brass
Article Number	SCBC-4
Price	140 €

The revolutionary StayHot&Cold combi plates offer temperatures from extreme cold (-5 °C) to searing heat (+140 °C) – all in the same product! With such versatile features, it's perfect for any type of restaurant buffet. Choose between a variety of models including built-in, freestanding versions, wells and more.



↑ Holiday Inn Stanstead
Photo: Catertherm UK

*Built-in plates
that suit all
buffet types.*



↑ IKEA Sundsvall
Photo: Stayhot

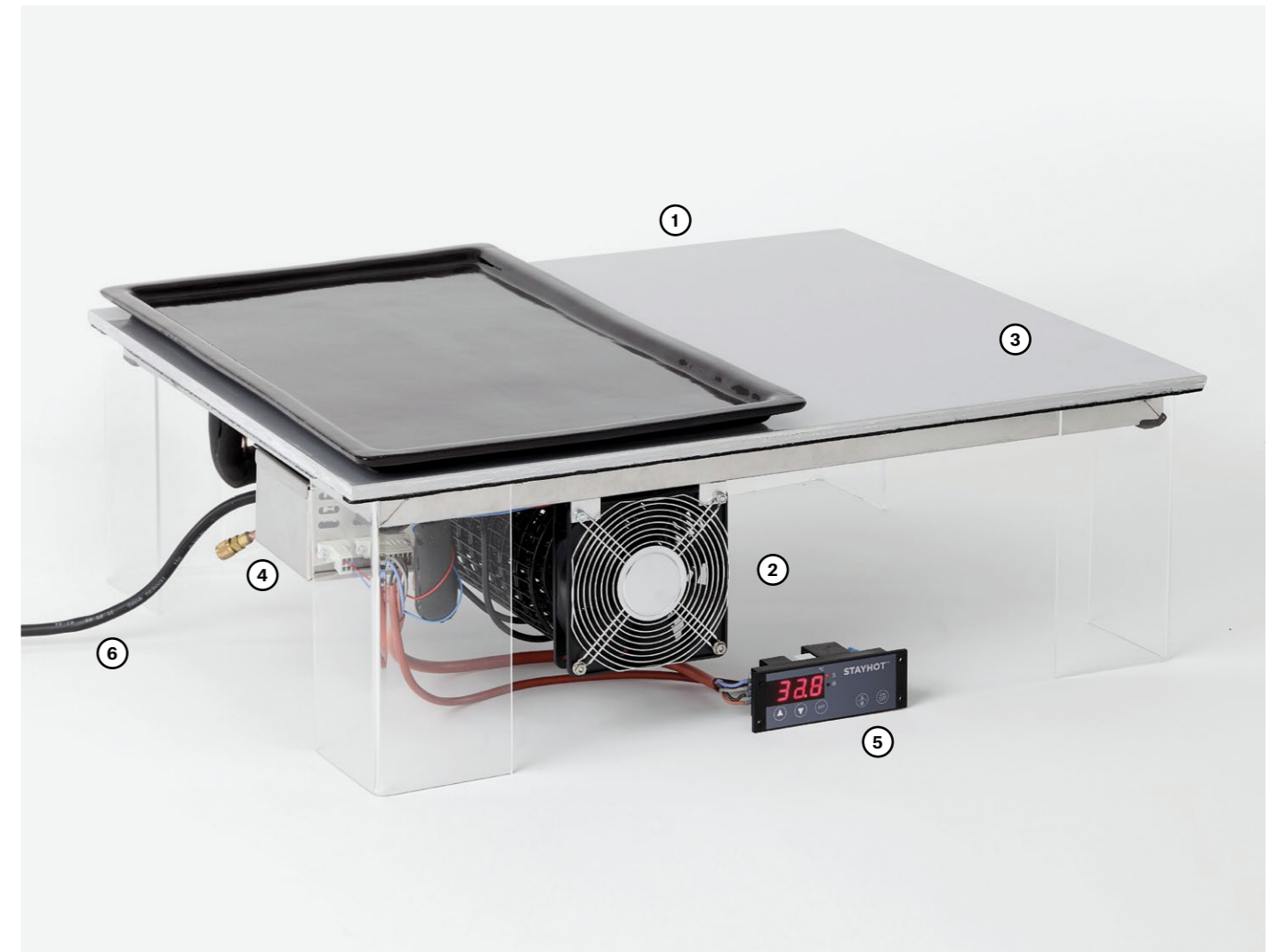

Get to know our Combi Plates

01

Cut-out Dimensions

The cut-out measurements for our combi plates are the outer dimensions +5 mm for each side. This is based on a support construction below the product, on which the plate is resting. This is used to perfect the height using adjustable screws, Silicone is then used to seal the edges. If the bench is made of Corian, the cut-out dimensions increase by 2 mm per side.

02

Ventilation & Fan

In order for the combi plates to work optimally, it is critical that there is plenty of air flow underneath. The temperature in the space below the plate should not exceed +40 °C. An easy way to ensure supply and exhaust air is to install two ventilation holes on each side of the fan. The cooling compressor then works optimally and prevents overheating.

03

Top Surface

The top surface is made out of aluminium as a base and stainless steel on top of that. You can also order the plates with Gorilla Glass in four different RAL colours.

04

Compressor

All of our combi and cold plates have compact and efficient compressors. It is also possible to choose plates without a built-in compressor, for installation to an external cooling system.

05

Control Panel

Control the temperature easily with the digital display. Go from searing heat and freezing cold with the push of a button.

06

Power Cable

All combi plates come with a two meter long power cable.

StayHot&Cold Combi Plates

Built-in Compressor

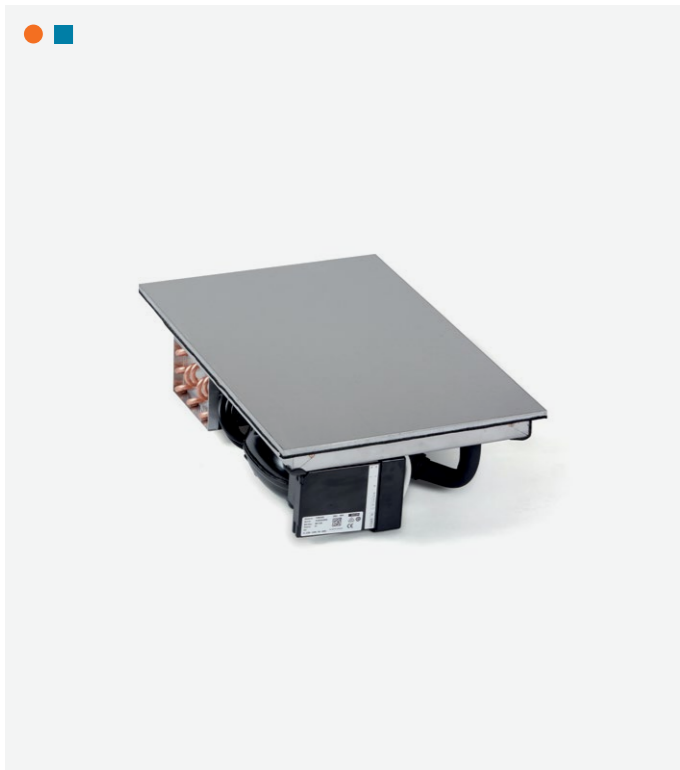

**Combi Plate GN 1/1
Built-in Compressor**

Combi Plate with built-in compressor, ready to plug in.
Temperature adjustable from -5 °C to +140 °C.

Top Surface	9,5 mm multi-layer material Aluminium / Stainless Steel
Dimensions	530 x 330 x 160 mm
Cut-out Dimensions	540 x 340 mm (Corian 544 x 344 mm)
Voltage	230 V, 50/60 Hz
Power	850 W
Cables	1 m controller cable / 2 m power supply
Requirements	Supply- and exhaust air must be ensured

Article Number SHC-GN-1/1
Price **3179 €**

Optional	Glass Coating 2 mm Gorilla Glass
Colours (RAL)	● 9004 ○ 9010 ● 7021 ● 7016
Article Number	SHC-GN-1/1-GLAS
Price	268 €

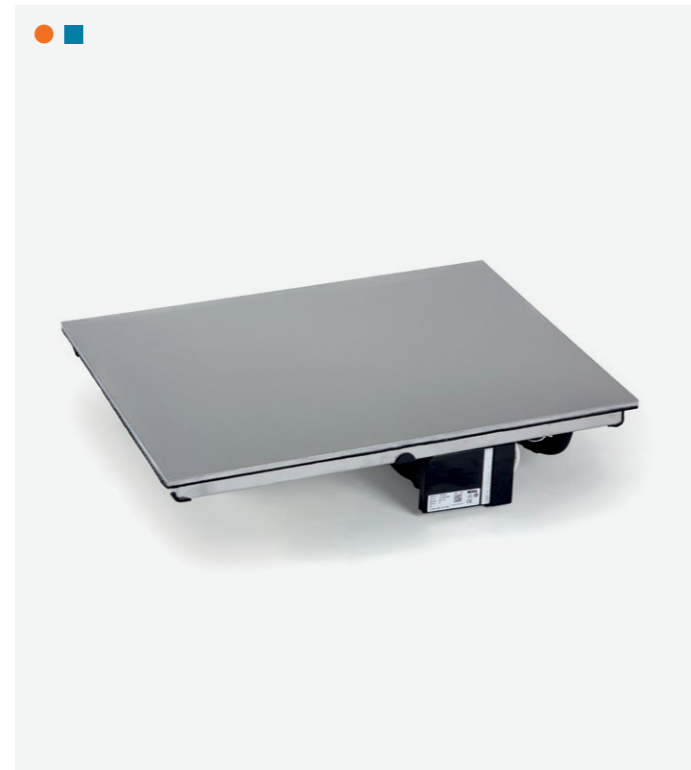

**Combi Plate GN 2/1
Built-in Compressor**

Combi Plate with built-in compressor, ready to plug in.
Temperature adjustable from -5 °C to +140 °C.

Top Surface	9,5 mm multi-layer material Aluminium / Stainless Steel
Dimensions	530 x 660 x 160 mm
Cut-out Dimensions	540 x 670 mm (Corian 544 x 674 mm)
Voltage	230 V, 50/60 Hz
Power	1520 W
Cables	1 m controller cable / 2 m power supply
Requirements	Supply- and exhaust air must be ensured

Article Number SHC-GN-2/1
Price **3883 €**

Optional	Glass Coating 2 mm Gorilla Glass
Colours (RAL)	● 9004 ○ 9010 ● 7021 ● 7016
Article Number	SHC-GN-2/1-GLAS
Price	402 €

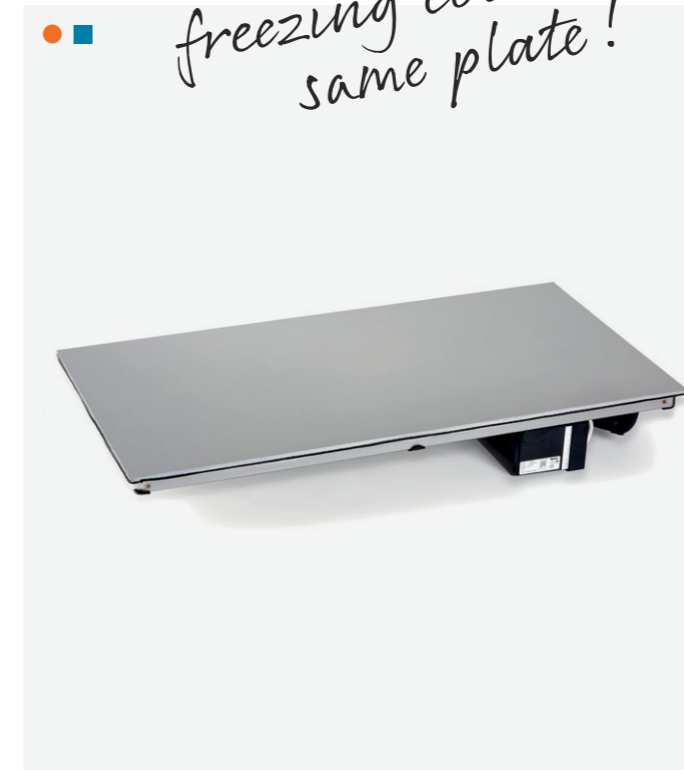

**Combi Plate GN 3/1
Built-in Compressor**

Combi Plate with built-in compressor, ready to plug in.
Temperature adjustable from -5 °C to +140 °C.

Top Surface	9,5 mm multi-layer material Aluminium / Stainless Steel
Dimensions	530 x 990 x 160 mm
Cut-out Dimensions	540 x 1000 mm (Corian 544 x 1004 mm)
Voltage	230 V, 50/60 Hz
Power	2340 W
Cables	1 m controller cable / 2 m power supply
Requirements	Supply- and exhaust air must be ensured

Article Number SHC-GN-3/1
Price **4576 €**

Optional	Glass Coating 2 mm Gorilla Glass
Colours (RAL)	● 9004 ○ 9010 ● 7021 ● 7016
Article Number	SHC-GN-3/1-GLAS
Price	539 €



**Combi Plate Round
Built-in Compressor**

Combi Plate with built-in compressor, ready to plug in.
Temperature adjustable from -5 °C to +140 °C.

Top Surface	9,5 mm multi-layer material Aluminium / Stainless Steel
Dimensions	Ø 490 x 160 mm
Cut-out Dimensions	Ø 500 mm (Corian Ø 504 mm)
Voltage	230 V, 50/60 Hz
Power	700 W
Cables	1 m controller cable / 2 m power supply
Requirements	Supply- and exhaust air must be ensured

Article Number SHC-R
Price **3534 €**

Optional	Glass Coating 5 mm
Colours (RAL)	● 9004 ○ 9010 ● 7021 ● 7016
Article Number	SHC-R-GLAS
Price	234 €

StayHot&Cold Combi Plates

Central Cooling

Connect to central cooling with these plates.

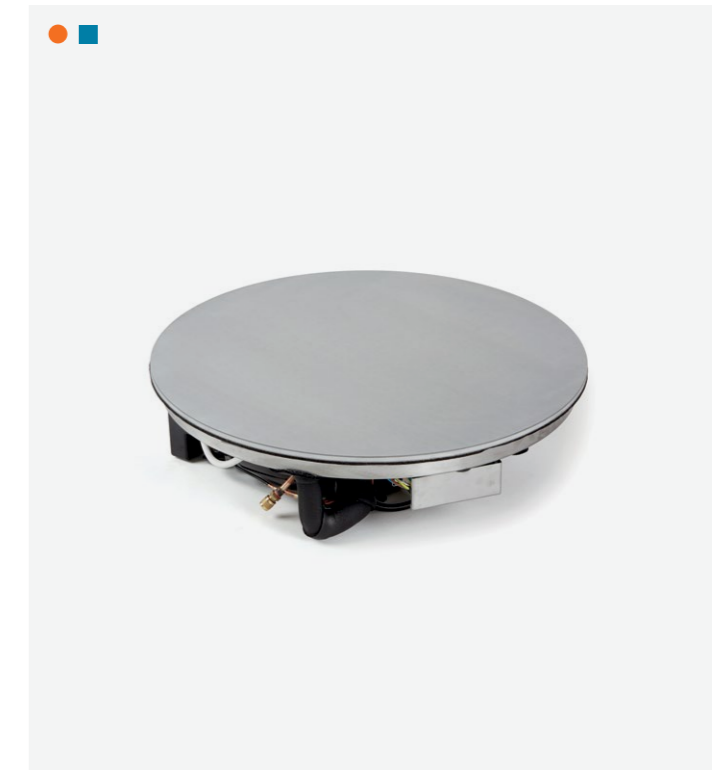
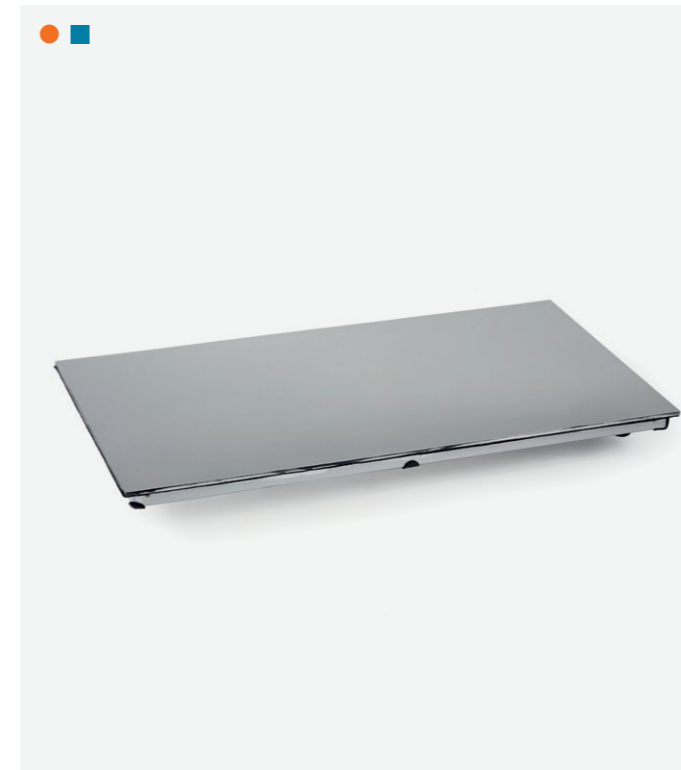
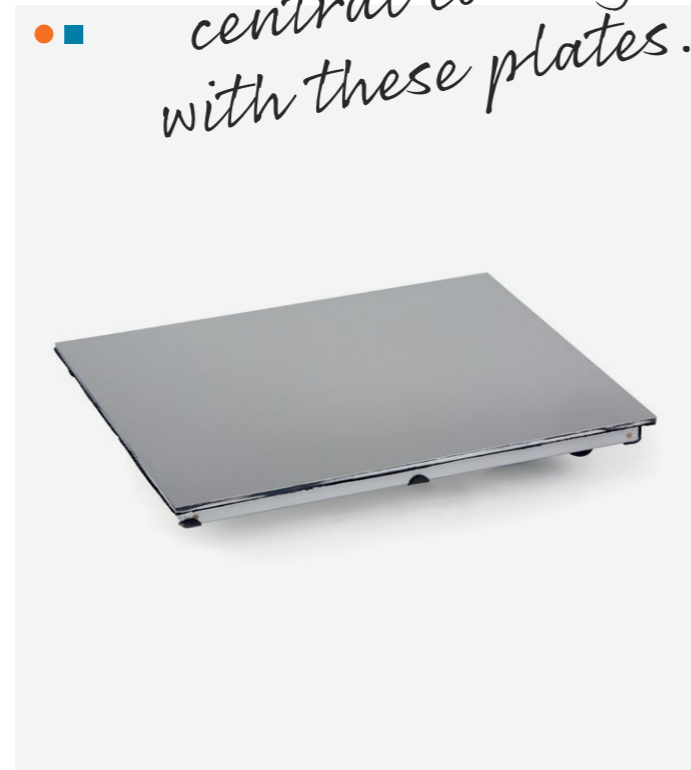
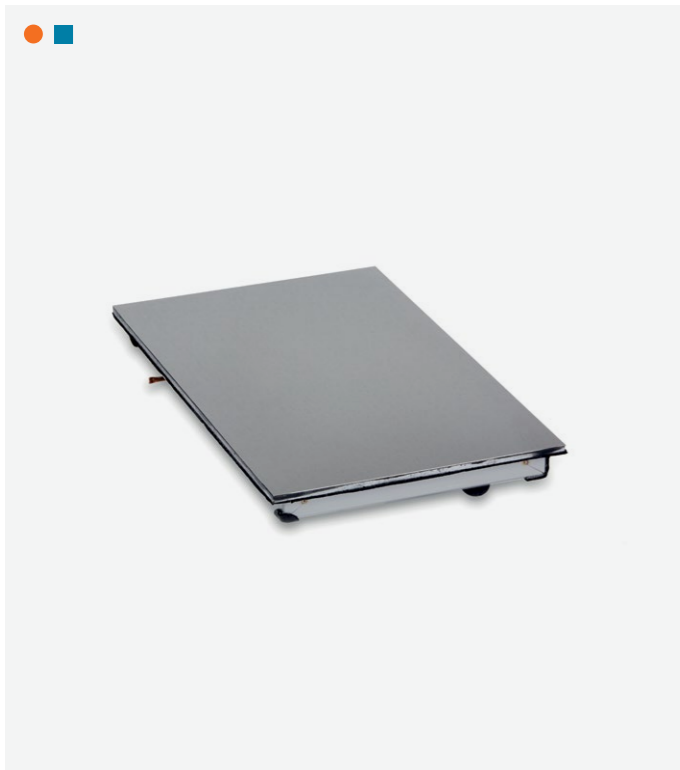

Combi Plate GN 1/1 Central Cooling

Combi Plate for installation to central cooling.
Temperature adjustable from -5 °C to +140 °C.

Top Surface	9,5 mm multi-layer material Aluminium / Stainless Steel
Dimensions	530 x 330 x 140 mm
Cut-out Dimensions	540 x 340 mm (Corian 544 x 344 mm)
Voltage	230 V, 50/60 Hz
Power	850 W
Cables	1 m controller cable / 2 m power supply
Refrigerant fluid	R134a, R404a, R507a

Article Number	SHC-GN-1/1-CKYLA
Price	3075 €

Optional	Glass Coating 2 mm Gorilla Glass
Colours (RAL)	● 9004 ○ 9010 ● 7021 ● 7016
Article Number	SHC-GN-1/1-GLAS
Price	268 €

Combi Plate GN 2/1 Central Cooling

Combi Plate for installation to central cooling.
Temperature adjustable from -5 °C to +140 °C.

Top Surface	9,5 mm multi-layer material Aluminium / Stainless Steel
Dimensions	530 x 660 x 140 mm
Cut-out Dimensions	540 x 670 mm (Corian 544 x 674 mm)
Voltage	230 V, 50/60 Hz
Power	1520 W
Cables	1 m controller cable / 2 m power supply
Refrigerant fluid	R134a, R404a, R507a

Article Number	SHC-GN-2/1-CKYLA
Price	3780 €

Optional	Glass Coating 2 mm Gorilla Glass
Colours (RAL)	● 9004 ○ 9010 ● 7021 ● 7016
Article Number	SHC-GN-2/1-GLAS
Price	402 €

Combi Plate GN 3/1 Central Cooling

Combi Plate for installation to central cooling.
Temperature adjustable from -5 °C to +140 °C.

Top Surface	9,5 mm multi-layer material Aluminium / Stainless Steel
Dimensions	530 x 990 x 140 mm
Cut-out Dimensions	540 x 1000 mm (Corian 544 x 1004 mm)
Voltage	230 V, 50/60 Hz
Power	2340 W
Cables	1 m controller cable / 2 m power supply
Refrigerant fluid	R134a, R404a, R507a

Article Number	SHC-GN-3/1-CKYLA
Price	4472 €

Optional	Glass Coating 2 mm Gorilla Glass
Colours (RAL)	● 9004 ○ 9010 ● 7021 ● 7016
Article Number	SHC-GN-3/1-GLAS
Price	539 €

Combi Plate Round Central Cooling

Combi Plate for installation to central cooling.
Temperature adjustable from -5 °C to +140 °C.

Top Surface	9,5 mm multi-layer material Aluminium / Stainless Steel
Dimensions	Ø 490 x 140 mm
Cut-out Dimensions	Ø 500 mm (Corian Ø 504 mm)
Voltage	230 V, 50/60 Hz
Power	700 W
Cables	1 m controller cable / 2 m power supply
Refrigerant fluid	R134a, R404a, R507a

Article Number	SHC-R-CKYLA
Price	3428 €

Optional	Glass Coating 5 mm
Colours (RAL)	● 9004 ○ 9010 ● 7021 ● 7016
Article Number	SHC-R-GLAS
Price	234 €

StayHot&Cold Cold Plates

Built-in Compressor



**Cold Plate GN 1/1
Built-in Compressor**

Cold Plate with built-in compressor, ready to plug in.
Temperature adjustable from -5 °C to +15 °C.

Top Surface	9,5 mm multi-layer material Aluminium / RFR
Dimensions	530 x 330 x 160 mm
Cut-out Dimensions	540 x 340 mm (Corian 544 x 344 mm)
Voltage	230 V, 50/60 Hz
Power	70 W
Cables	1 m controller cable / 2 m power supply
Requirements	Supply- and exhaust air must be ensured

Article Number SHC-C-GN-1/1-KYLA
Price **2990 €**

Optional Glass Coating 2 mm Gorilla Glass
Colours (RAL) ● 9004 ○ 9010 ● 7021 ● 7016
Article Number SHC-GN-1/1-GLAS
Price **268 €**

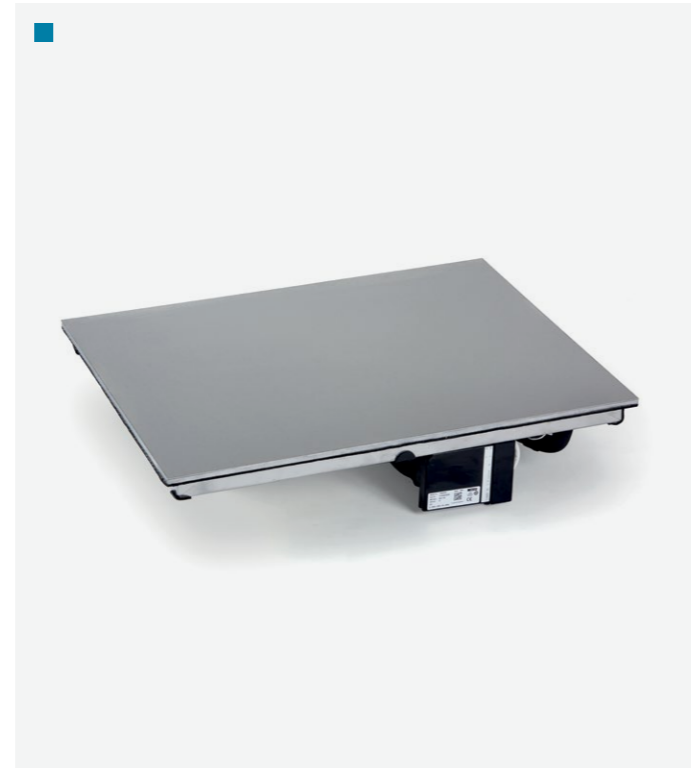

**Cold Plate GN 2/1
Built-in Compressor**

Cold Plate with built-in compressor, ready to plug in.
Temperature adjustable from -5 °C to +15 °C.

Top Surface	9,5 mm multi-layer material Aluminium / RFR
Dimensions	530 x 660 x 160 mm
Cut-out Dimensions	540 x 670 mm (Corian 544 x 674 mm)
Voltage	230 V, 50/60 Hz
Power	140 W
Cables	1 m controller cable / 2 m power supply
Requirements	Supply- and exhaust air must be ensured

Article Number SHC-C-GN-2/1-KYLA
Price **3659 €**

Optional Glass Coating 2 mm Gorilla Glass
Colours (RAL) ● 9004 ○ 9010 ● 7021 ● 7016
Article Number SHC-GN-2/1-GLAS
Price **402 €**

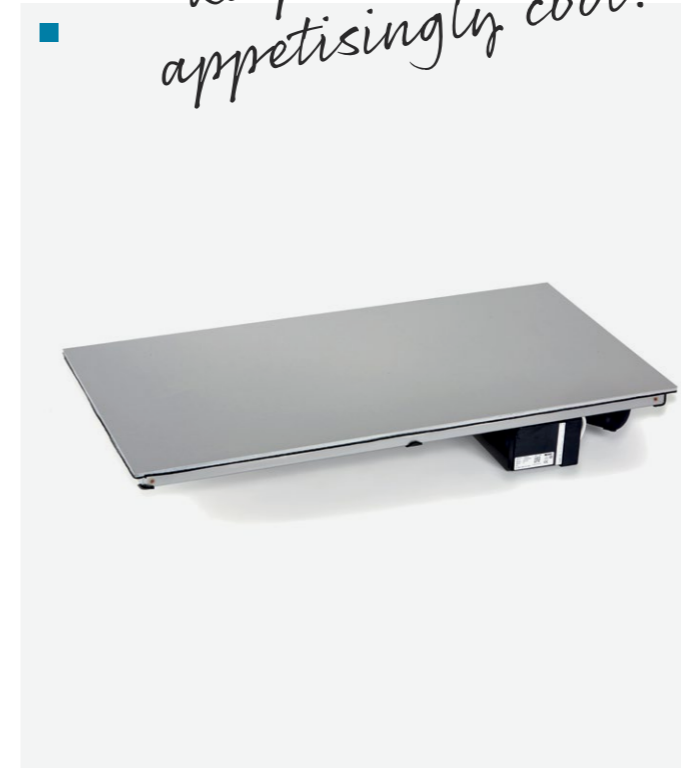

*Our cold plates
keep the buffet
appetisingly cool.*

**Cold Plate GN 3/1
Built-in Compressor**

Cold Plate with built-in compressor, ready to plug in.
Temperature adjustable from -5 °C to +15 °C.

Top Surface	9,5 mm multi-layer material Aluminium / RFR
Dimensions	530 x 990 x 160 mm
Cut-out Dimensions	540 x 1000 mm (Corian 544 x 1004 mm)
Voltage	230 V, 50/60 Hz
Power	210 W
Cables	1 m controller cable / 2 m power supply
Requirements	Supply- and exhaust air must be ensured

Article Number SHC-C-GN-3/1-KYLA
Price **4313 €**

Optional Glass Coating 2 mm Gorilla Glass
Colours (RAL) ● 9004 ○ 9010 ● 7021 ● 7016
Article Number SHC-GN-3/1-GLAS
Price **539 €**

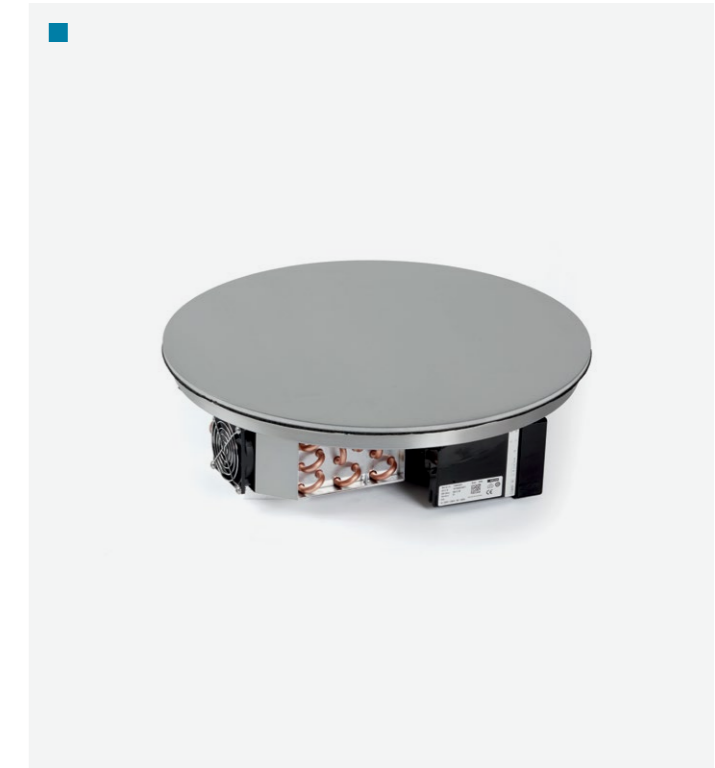

**Cold Plate Round
Built-in Compressor**

Cold Plate with built-in compressor, ready to plug in.
Temperature adjustable from -5 °C to +15 °C.

Top Surface	9,5 mm multi-layer material Aluminium / RFR
Dimensions	Ø 490 x 160 mm
Cut-out Dimensions	Ø 500 mm (Corian Ø 504 mm)
Voltage	230 V, 50/60 Hz
Power	70 W
Cables	1 m controller cable / 2 m power supply
Requirements	Supply- and exhaust air must be ensured

Article Number SHC-C-R-KYLA
Price **3344 €**

Optional Glass Coating 5 mm
Colours (RAL) ● 9004 ○ 9010 ● 7021 ● 7016
Article Number SHC-R-GLAS
Price **234 €**

StayHot&Cold Cold Plates

Central Cooling



Cold Plate GN 1/1
Central Cooling

Cold Plate for installation to central cooling.
Temperature adjustable from -5 °C to +15 °C.

Top Surface	9.5 mm multi-layer material Aluminium / RFR
Dimensions	530 x 330 x 140 mm
Cut-out Dimensions	540 x 340 mm (Corian 544 x 344 mm)
Voltage	230 V, 50/60 Hz
Power	70 W
Cables	1 m controller cable / 2 m power supply
Refrigerant fluid	R134a, R404a, R507a

Article Number SHC-C-GN-1/1-KYLA-CKYLA
Price **2885 €**

Optional	Glass Coating 2 mm Gorilla Glass
Colours (RAL)	● 9004 ○ 9010 ● 7021 ● 7016
Article Number	SHC-GN-1/1-GLAS
Price	268 €



Cold Plate GN 2/1
Central Cooling

Cold Plate for installation to central cooling.
Temperature adjustable from -5 °C to +15 °C.

Top Surface	9,5 mm multi-layer material Aluminium / RFR
Dimensions	530 x 660 x 140 mm
Cut-out Dimensions	540 x 670 mm (Corian 544 x 674 mm)
Voltage	230 V, 50/60 Hz
Power	140 W
Cables	1 m controller cable / 2 m power supply
Refrigerant fluid	R134a, R404a, R507a

Article Number SHC-C-GN-2/1-KYLA-CKYLA
Price **3554 €**

Optional	Glass Coating 2 mm Gorilla Glass
Colours (RAL)	● 9004 ○ 9010 ● 7021 ● 7016
Article Number	SHC-GN-2/1-GLAS
Price	402 €



Cold Plate GN 3/1
Central Cooling

Cold Plate for installation to central cooling.
Temperature adjustable from -5 °C to +15 °C.

Top Surface	9,5 mm multi-layer material Aluminium / RFR
Dimensions	530 x 990 x 140 mm
Cut-out Dimensions	540 x 1000 mm (Corian 544 x 1004 mm)
Voltage	230 V, 50/60 Hz
Power	210 W
Cables	1 m controller cable / 2 m power supply
Refrigerant fluid	R134a, R404a, R507a

Article Number SHC-C-GN-3/1-KYLA-CKYLA
Price **4209 €**

Optional	Glass Coating 2 mm Gorilla Glass
Colours (RAL)	● 9004 ○ 9010 ● 7021 ● 7016
Article Number	SHC-GN-3/1-GLAS
Price	539 €

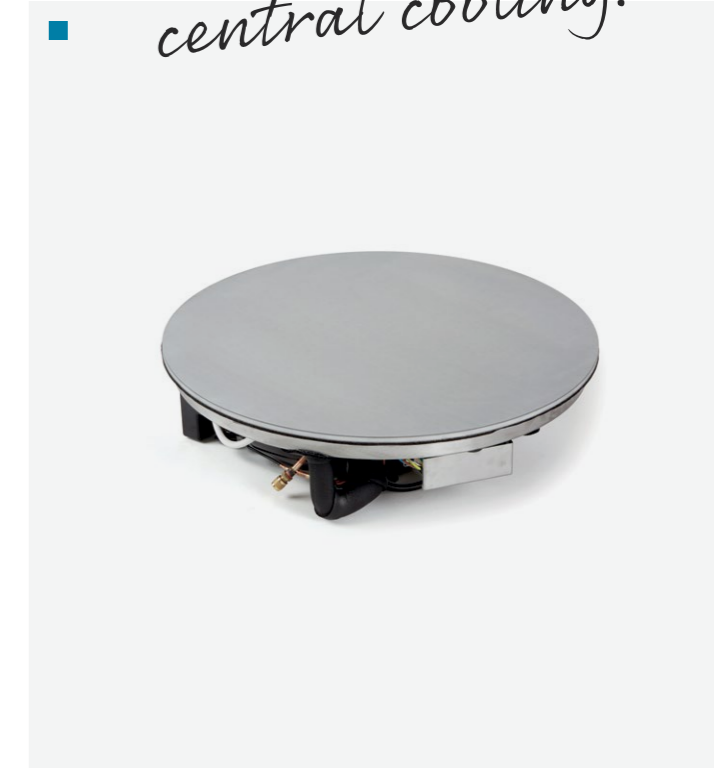

Cold Plate Round
Central Cooling

Cold Plate for installation to central cooling.
Temperature adjustable from -5 °C to +15 °C.

Top Surface	9,5 mm multi-layer material Aluminium / RFR
Dimensions	Ø 490 x 140 mm
Cut-out Dimensions	Ø 500 mm (Corian Ø 504 mm)
Voltage	230 V, 50/60 Hz
Power	70 W
Cables	1 m controller cable / 2 m power supply
Refrigerant fluid	R134a, R404a, R507a

Article Number SHC-C-R-KYLA-CKYLA
Price **3239 €**

Optional	Glass Coating 5 mm
Colours (RAL)	● 9004 ○ 9010 ● 7021 ● 7016
Article Number	SHC-R-GLAS
Price	234 €

These cold plates connect to central cooling.

StayHot&Cold Hot Plates

Recess Models



Hot Plate GN 1/1

Recess hot plate ready to plug in. Keeps heated food hot.
Temperature adjustable from +20 °C to +140 °C.

Top Surface	9,5 mm multi-layer material Aluminium / RFR
Dimensions	530 x 330 x 60 mm
Cut-out Dimensions	540 x 340 mm (Corian 544 x 344 mm)
Voltage	230 V, 50/60 Hz
Power	850 W
Cables	1 m controller cable / 2 m power supply

Article Number	SHC-H-GN-1/1-VÄRME
Price	1106 €

Optional	Glass Coating 2 mm Gorilla Glass
Colours (RAL)	● 9004 ○ 9010 ● 7021 ● 7016
Article Number	SHC-GN-1/1-GLAS
Price	268 €



Hot Plate GN 2/1

Recess hot plate ready to plug in. Keeps heated food hot.
Temperature adjustable from +20 °C to +140 °C.

Top Surface	9,5 mm multi-layer material Aluminium / RFR
Dimensions	530 x 660 x 60 mm
Cut-out Dimensions	540 x 670 mm (Corian 544 x 674 mm)
Voltage	230 V, 50/60 Hz
Power	1520 W
Cables	1 m controller cable / 2 m power supply

Article Number	SHC-H-GN-2/1-VÄRME
Price	1570 €

Optional	Glass Coating 2 mm Gorilla Glass
Colours (RAL)	● 9004 ○ 9010 ● 7021 ● 7016
Article Number	SHC-GN-2/1-GLAS
Price	402 €



Hot Plate GN 3/1

Recess hot plate ready to plug in. Keeps heated food hot.
Temperature adjustable from +20 °C to +140 °C.

Top Surface	9,5 mm multi-layer material Aluminium / RFR
Dimensions	530 x 990 x 60 mm
Cut-out Dimensions	540 x 1000 mm (Corian 544 x 1004 mm)
Voltage	230 V, 50/60 Hz
Power	2340 W
Cables	1 m controller cable / 2 m power supply

Article Number	SHC-H-GN-3/1-VÄRME
Price	2033 €

Optional	Glass Coating 2 mm Gorilla Glass
Colours (RAL)	● 9004 ○ 9010 ● 7021 ● 7016
Article Number	SHC-GN-3/1-GLAS
Price	539 €

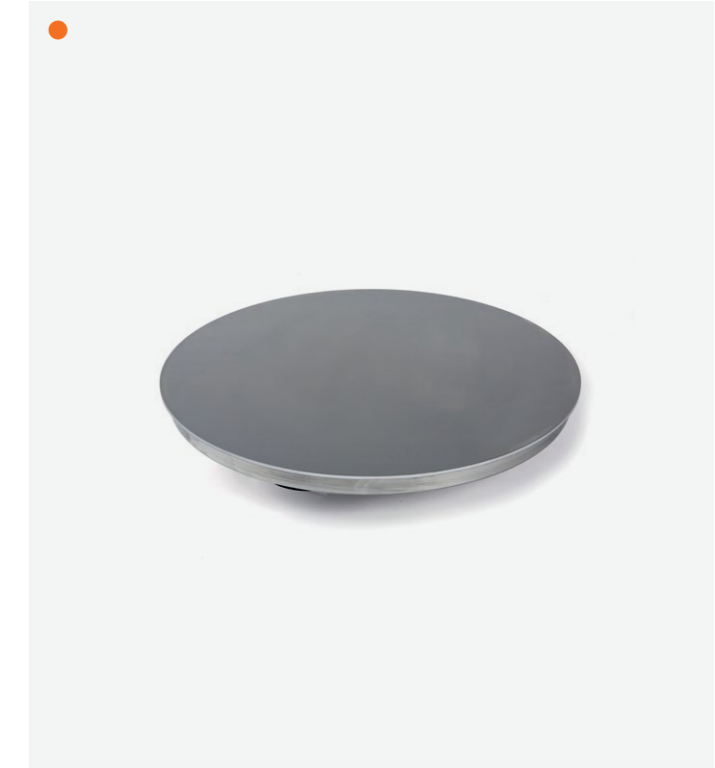

Hot Plate Round

Recess hot plate ready to plug in. Keeps heated food hot.
Temperature adjustable from +20 °C to +140 °C.

Top Surface	9,5 mm multi-layer material Aluminium / RFR
Dimensions	Ø 490 x 60 mm
Cut-out Dimensions	Ø 500 mm (Corian Ø 504 mm)
Voltage	230 V, 50/60 Hz
Power	700 W
Cables	1 m controller cable / 2 m power supply

Article Number	SHC-H-R-VÄRME
Price	1240 €

Optional	Glass Coating 5 mm
Colours (RAL)	● 9004 ○ 9010 ● 7021 ● 7016
Article Number	SHC-R-GLAS
Price	234 €

StayHot&Cold Freestanding Combi Plates Built-in Compressor

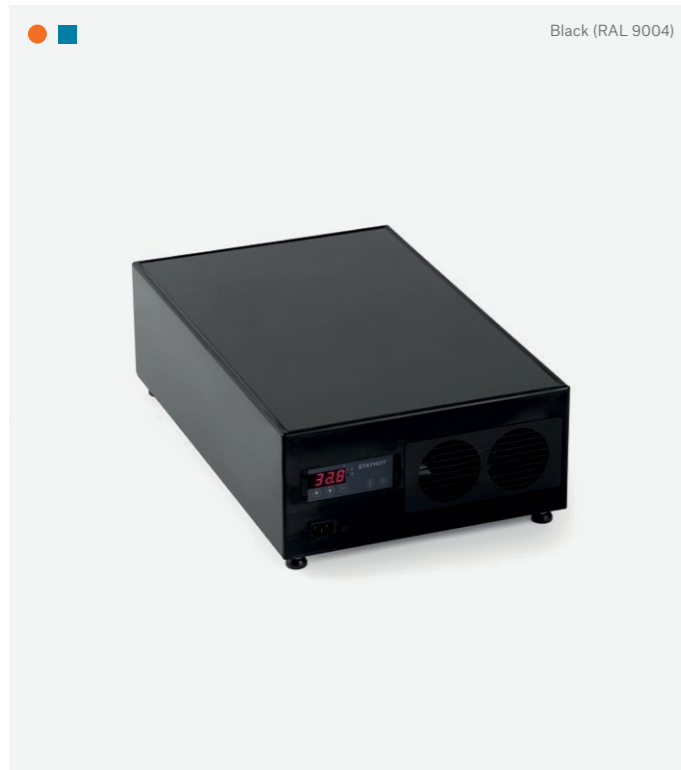

**Freestanding Combi Plate GN 1/1
Built-in Compressor**

Freestanding combi plate with built in compressor. Temperature adjustable from -5 °C to +140 °C. External cover made out of Gorilla Glass. Choose between White (RAL 9010) and Black (RAL 9004).

Dimensions	530 x 330 x 145 mm
Voltage	230 V, 50/60 Hz
Power	850 W
Cables	2 m power supply

External cover	2 mm Gorilla Glass
Colours (RAL)	● 9004 ○ 9010

Article Number	SHC-F-GN-1/1
Price	3945 €



**Freestanding Combi Plate GN 2/1
Built-in Compressor**

Freestanding combi plate with built in compressor. Temperature adjustable from -5 °C to +140 °C. External cover made out of Gorilla Glass. Choose between White (RAL 9010) and Black (RAL 9004).

Dimensions	530 x 660 x 145 mm
Voltage	230 V, 50/60 Hz
Power	1520 W
Cables	2 m power supply

External cover	2 mm Gorilla Glass
Colours (RAL)	● 9004 ○ 9010

Article Number	SHC-F-GN-2/1
Price	4770 €

StayHot&Cold Freestanding Cold Plates Built-in Compressor

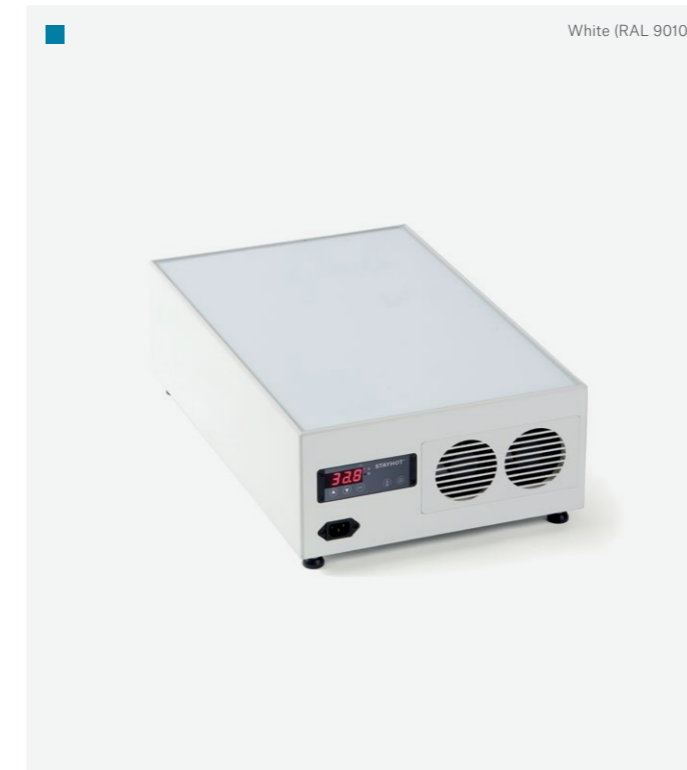

**Freestanding Cold Plate GN 1/1
Built-in Compressor**

Freestanding cold plate with built in compressor. Temperature adjustable from -5 °C to +15 °C. External cover made out of Gorilla Glass. Choose between White (RAL 9010) and Black (RAL 9004).

Dimensions	530 x 330 x 145 mm
Voltage	230 V, 50/60 Hz
Power	70 W
Cables	2 m power supply

External cover	2 mm Gorilla Glass
Colours (RAL)	● 9004 ○ 9010

Article Number	SHC-FC-GN-1/1-KYLA
Price	38 05 €



**Freestanding Cold Plate GN 2/1
Built-in Compressor**

Freestanding cold plate with built in compressor. Temperature adjustable from -5 °C to +15 °C. External cover made out of Gorilla Glass. Choose between White (RAL 9010) and Black (RAL 9004).

Dimensions	530 x 660 x 145 mm
Voltage	230 V, 50/60 Hz
Power	140 W
Cables	2 m power supply

External cover	2 mm Gorilla Glass
Colours (RAL)	● 9004 ○ 9010

Article Number	SHC-FC-GN-2/1-KYLA
Price	46 27 €

Our freestanding models offer a flexible food warming solution!

StayHot&Cold

Freestanding Hot Plates



Freestanding Hot Plate GN 1/1

Freestanding hot plate, ready to plug in. Temperature adjustable from +20 °C till +140 °C. External cover made out of Gorilla Glass or Stainless Steel. Choose between White (RAL 9010), Black (RAL 9004), or Stainless Steel (RFR).

Dimensions	530 x 330 x 60 mm
Voltage	230 V, 50/60 Hz
Power	850 W
Cables	2 m power supply

External cover	2 mm Gorilla Glass / Stainless Steel
Colours (RAL)	● 9004 ○ 9010 ● RFR

Article Number	SHC-FH-GN-1/1-VÄRME
Price	1429 €



Freestanding Hot Plate GN 2/1

Freestanding hot plate, ready to plug in. Temperature adjustable from +20 °C till +140 °C. External cover made out of Gorilla Glass or Stainless Steel. Choose between White (RAL 9010), Black (RAL 9004), or Stainless Steel (RFR).

Dimensions	530 x 660 x 60 mm
Voltage	230 V, 50/60 Hz
Power	1520 W
Cables	2 m power supply

External cover	2 mm Gorilla Glass / Stainless Steel
Colours (RAL)	● 9004 ○ 9010 ● RFR

Article Number	SHC-FH-GN-2/1-VÄRME
Price	2028 €



Freestanding Hot Plate GN 3/1

Freestanding hot plate, ready to plug in. Temperature adjustable from +20 °C till +140 °C. External cover made out of Gorilla Glass or Stainless Steel. Choose between White (RAL 9010), Black (RAL 9004), or Stainless Steel (RFR).

Dimensions	530 x 990 x 60 mm
Voltage	230 V, 50/60 Hz
Power	2340 W
Cables	2 m power supply

External cover	2 mm Gorilla Glass / Stainless Steel
Colours (RAL)	● 9004 ○ 9010 ● RFR

Article Number	SHC-FH-GN-3/1-VÄRME
Price	2628 €

Keep your food appetisingly warm with our efficient and stylish hot plates.

Perfect for anyone in need of a movable and flexible heat source for the breakfast and lunch buffet.

Choose from three different sizes in gastronorm dimensions and three external cover colours.

StayHot&Cold Combi Wells

Built-in Compressor / Central Cooling



Combi Well GN 1/1
Built-in Compressor / Central Cooling

Combi Well with built-in compressor or for installation to central cooling. Temperature adjustable from -5 °C to +140 °C.

Dimensions	425 x 630 x 250 mm (Built-in Compressor)
Dimensions	425 x 630 x 230 mm (Central Cooling)
Cut-out Dimensions	375 x 580 mm
Voltage	230 V, 50/60 Hz
Power	900 W (Built-in Compressor)
Power	70 W (Central Cooling)
Cables	1 m controller cable / 2 m power supply
Requirements	Supply- and exhaust air must be ensured
Refrigerant fluid	R134a, R404a, R507a

Article Number	SHC-GN-1/1-BRUNN
Price	4090 €

Article Number	SHC-GN-1/1-BRUNN-CKYLA
Price	3974 €

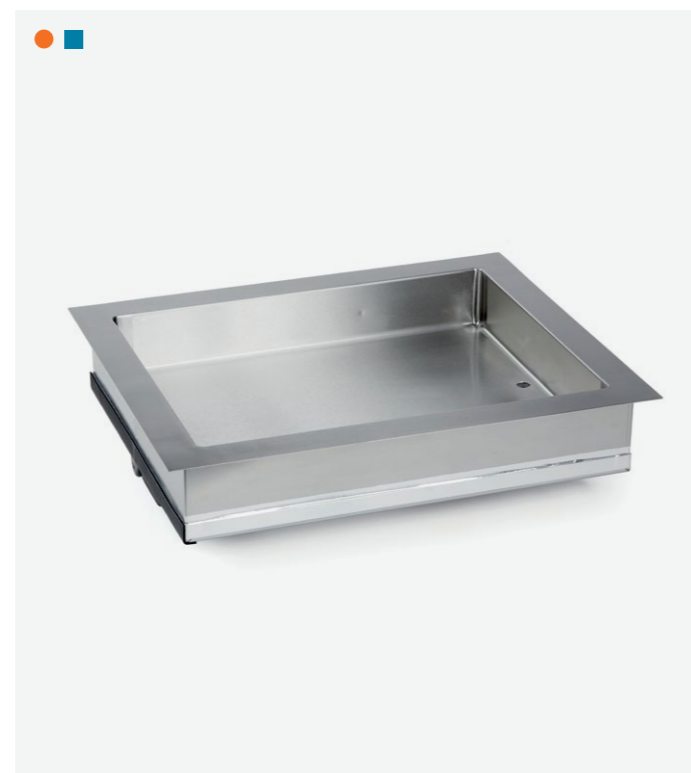

Combi Well GN 2/1
Built-in Compressor / Central Cooling

Combi Well with built-in compressor or for installation to central cooling. Temperature adjustable from -5 °C to +140 °C.

Dimensions	770 x 630 x 250 mm (Built-in Compressor)
Dimensions	770 x 630 x 230 mm (Central Cooling)
Cut-out Dimensions	720 x 580 mm
Voltage	230 V, 50/60 Hz
Power	1800 W (Built-in Compressor)
Power	140 W (Central Cooling)
Cables	1 m controller cable / 2 m power supply
Requirements	Supply- and exhaust air must be ensured
Refrigerant fluid	R134a, R404a, R507a

Article Number	SHC-GN-2/1-BRUNN
Price	4793 €

Article Number	SHC-GN-2/1-BRUNN-CKYLA
Price	4675 €

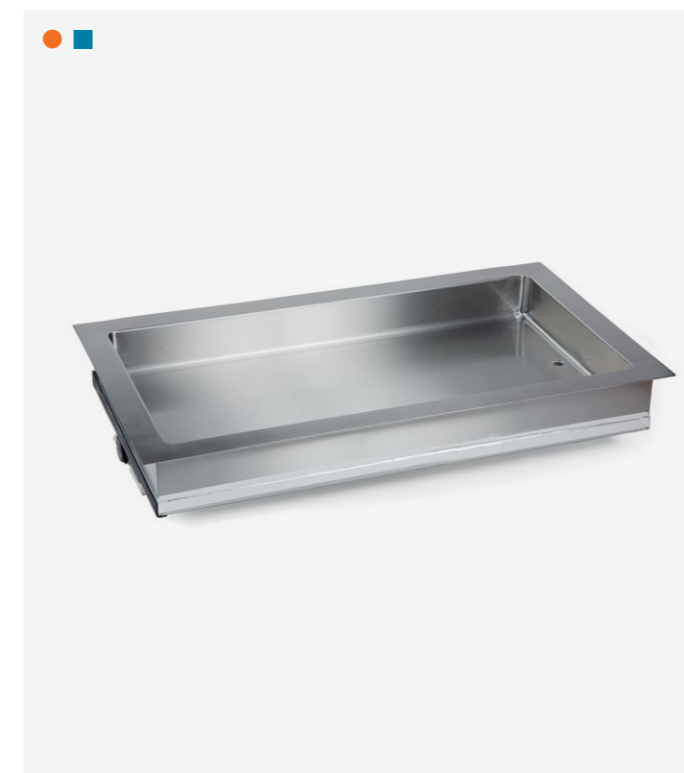

Combi Well GN 3/1
Built-in Compressor / Central Cooling

Combi Well with built-in compressor or for installation to central cooling. Temperature adjustable from -5 °C to +140 °C.

Dimensions	1100 x 630 x 250 mm (Built-in Compressor)
Dimensions	1100 x 630 x 230 mm (Central Cooling)
Cut-out Dimensions	1060 x 580 mm
Voltage	230 V, 50/60 Hz
Power	2700 W (Built-in Compressor)
Power	210 W (Central Cooling)
Cables	1 m controller cable / 2 m power supply
Requirements	Supply- and exhaust air must be ensured
Refrigerant fluid	R134a, R404a, R507a

Article Number	SHC-GN-3/1-BRUNN
Price	5612 €

Article Number	SHC-GN-3/1-BRUNN-CKYLA
Price	5496 €

We offer our combi wells in three gastronorm dimensions (GN 1/1, 2/1 and 3/1). They can be purchased with a built-in compressor or for installation to central cooling.

StayHot&Cold Cold Wells

Built-in Compressor / Central Cooling



Our cold wells are available in three gastronorm dimensions (GN 1/1, 2/1 & 3/1) and can be purchased with a built-in compressor or for installation to central cooling.

Cold Well GN 1/1 Built-in Compressor / Central Cooling

Cold Well with built-in compressor or for installation to central cooling. Temperature adjustable from -5 °C to +15 °C.

Dimensions	425 x 630 x 250 mm (Built-in Compressor)
Dimensions	425 x 630 x 230 mm (Central Cooling)
Cut-out Dimensions	375 x 580 mm
Voltage	230 V, 50/60 Hz
Power	70 W
Cables	1 m controller cable / 2 m power supply
Requirements	Supply- and exhaust air must be ensured
Refrigerant fluid	R134a, R404a, R507a

Article Number SHC-C-GN-1/1-BRUNN-KYLA
Price **3796 €**

Article Number SHC-C-GN-1/1-BRUNN-CKYLA-KYLA
Price **3681 €**



Cold Well GN 2/1 Built-in Compressor / Central Cooling

Cold Well with built-in compressor or for installation to central cooling. Temperature adjustable from -5 °C to +15 °C.

Dimensions	770 x 630 x 250 mm (Built-in Compressor)
Dimensions	770 x 630 x 230 mm (Central Cooling)
Cut-out Dimensions	720 x 580 mm
Voltage	230 V, 50/60 Hz
Power	140 W
Cables	1 m controller cable / 2 m power supply
Requirements	Supply- and exhaust air must be ensured
Refrigerant fluid	R134a, R404a, R507a

Article Number SHC-C-GN-2/1-BRUNN-KYLA
Price **4500 €**

Article Number SHC-C-GN-2/1-BRUNN-CKYLA-KYLA
Price **4383 €**

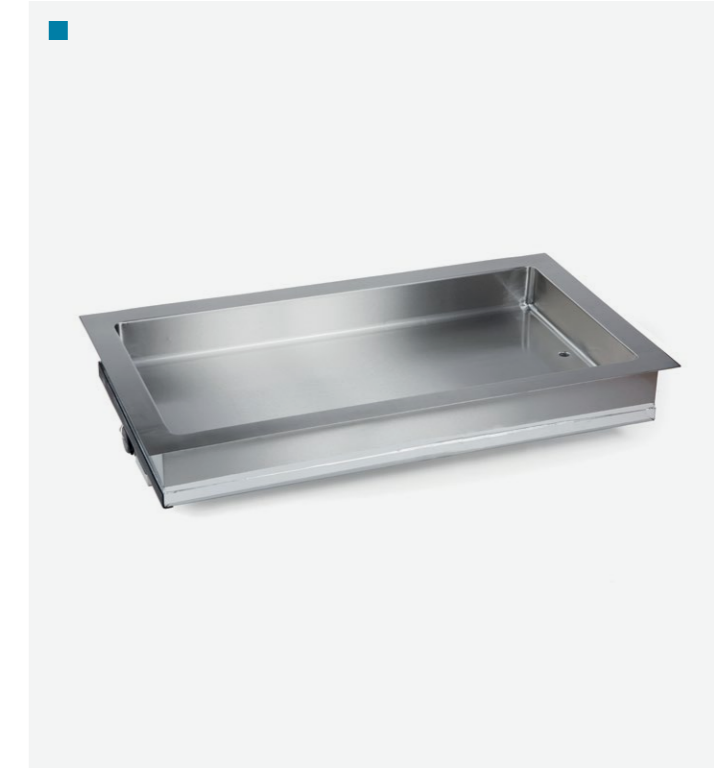

Cold Well GN 3/1 Built-in Compressor / Central Cooling

Cold Well with built-in compressor or for installation to central cooling. Temperature adjustable from -5 °C to +15 °C.

Dimensions	1100 x 630 x 250 mm (Built-in Compressor)
Dimensions	1100 x 630 x 230 mm (Central Cooling)
Cut-out Dimensions	1060 x 580 mm
Voltage	230 V, 50/60 Hz
Power	210 W
Cables	1 m controller cable / 2 m power supply
Requirements	Supply- and exhaust air must be ensured
Refrigerant fluid	R134a, R404a, R507a

Article Number SHC-C-GN-3/1-BRUNN-KYLA
Price **5215 €**

Article Number SHC-C-GN-3/1-BRUNN-CKYLA-KYLA
Price **5202 €**

StayHot&Cold Hot Wells



Hot Well GN 1/1

Hot well ready to plug in.
Temperature adjustable from +20 °C to +140 °C.

Dimensions	425 x 630 x 250 mm
Cut-out Dimensions	375 x 580 mm
Voltage	230 V, 50/60 Hz
Power	900 W
Cables	1 m controller cable / 2 m power supply

Article Number	SHC-H-GN-1/1-BRUNN-VÄRME
Price	3233 €



Hot Well GN 2/1

Hot well ready to plug in.
Temperature adjustable from +20 °C to +140 °C.

Dimensions	770 x 630 x 250 mm
Cut-out Dimensions	720 x 580 mm
Voltage	230 V, 50/60 Hz
Power	1800 W
Cables	1 m controller cable / 2 m power supply

Article Number	SHC-H-GN-2/1-BRUNN-VÄRME
Price	3540 €

Our hot wells offer an elegant and effective solution for all types of buffets. You can choose between three gastronorm dimensions (GN 1/1, 2/1 + 3/1).

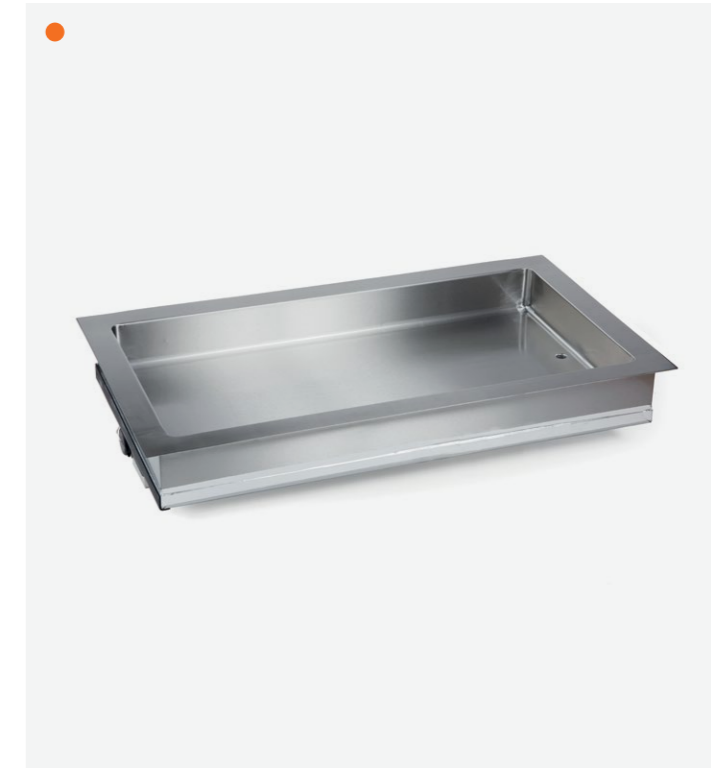

Hot Well GN 3/1

Hot well ready to plug in.
Temperature adjustable from +20 °C to +140 °C.

Dimensions	1100 x 630 x 250 mm
Cut-out Dimensions	1060 x 580 mm
Voltage	230 V, 50/60 Hz
Power	2700 W
Cables	1 m controller cable / 2 m power supply

Article Number	SHC-H-GN-3/1-BRUNN-VÄRME
Price	3859 €

Ice Plates



Wow your customers with our innovative Ice Plates! With a surface temperature of -30°C , you can easily create rolled ice cream and many other forms and shapes in a fun and creative way!

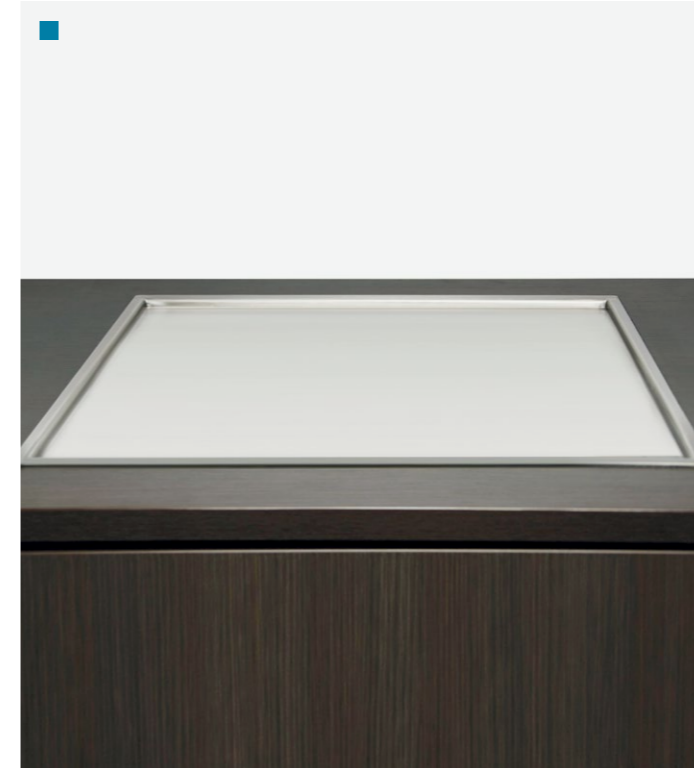
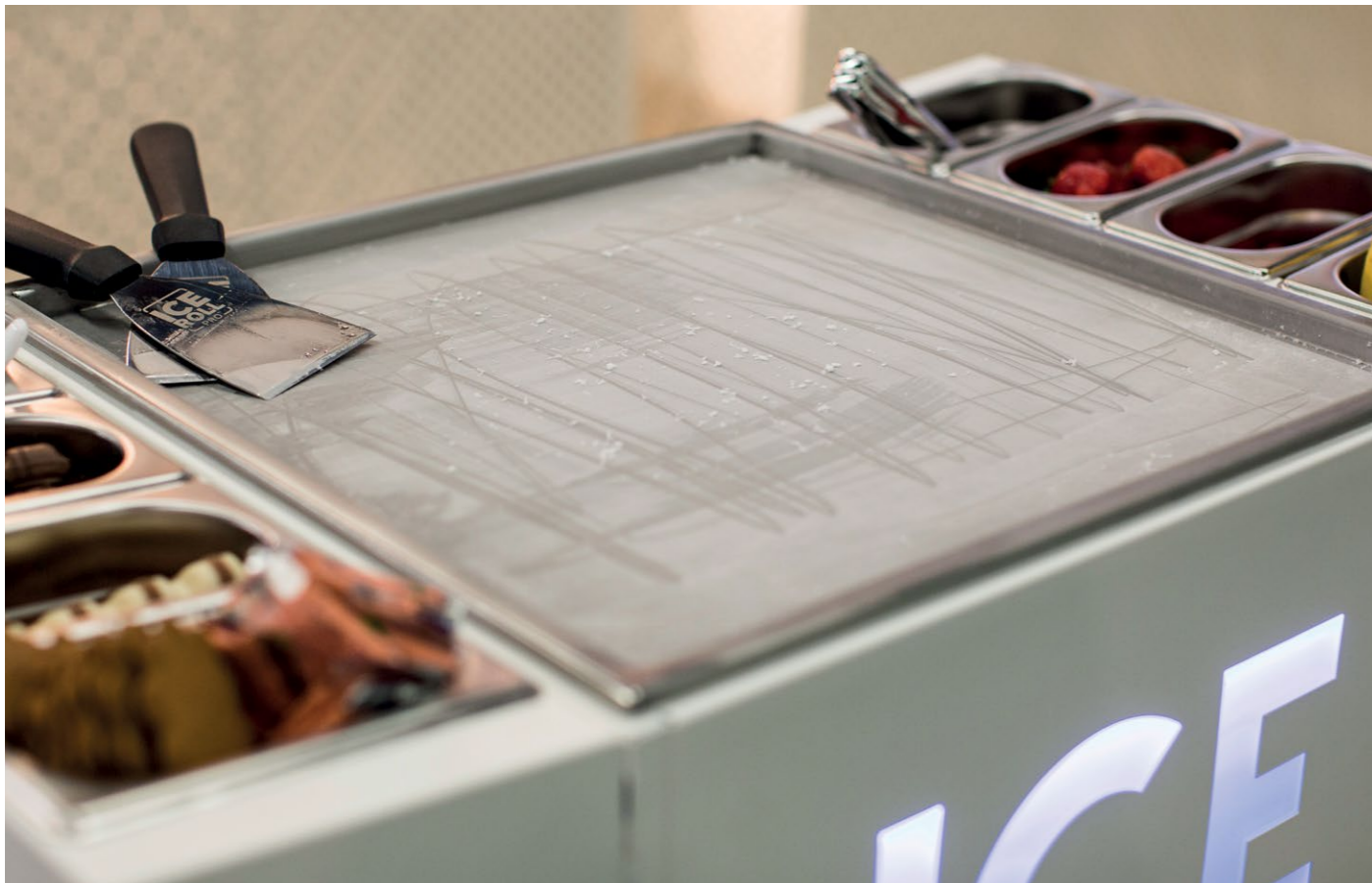

Ice Plate GN 1/1, 450 Built-in Compressor

Ice Plate with built-in compressor.
Temperature adjustable down to -30°C .

Dimensions	GN 1/1	530 x 330 x 250 mm
Dimensions	450	495 x 495 x 250 mm

Voltage	230 V, 50/60 Hz
Power	850 W
Cables	1 m controller cable / 2 m power supply
Requirements	Supply- and exhaust air must be ensured

Article Number	SHC-ICE-GN-1/1
Price	39 60 €

Article Number	SHC-ICE-450
Price	40 70 €



Ice Plate GN 1/1, 450 Built-in Compressor

Freestanding Ice Plate with built-in compressor.
Temperature adjustable down to -30°C . Ready to plug in and use.
Removable shelves, stainless steel containers and spatulas are all sold separately.

Dimensions	GN 1/1	545 x 345 x 330 mm
Dimensions	450	495 x 495 x 330 mm

Voltage	230 V, 50/60 Hz
Power	850 W
Cables	2 m power supply
Requirements	Supply- and exhaust air must be ensured

Article Number	SHC-F-ICE-GN-1/1
Price	44 77 €

Article Number	SHC-F-ICE-450
Price	48 24 €

Slice, chop, wedge, dice & cut with our reliable, functional & affordable range of food preparation equipment. Made from robust materials with razor sharp blades – these products offer a helping hand for the busy kitchen.

Dicers



Nemco Easy FryKutter

Dimensions 203 x 318 x 393 (mm)
 Material Cast Aluminium / Stainless Steel (Blades)
 Weight 5,4 kg
 Cutting Sizes 6,5 mm / 10 mm / 13 mm
 Article Number 55450-1 / 55450-2 / 55450-3
Price 684 €



Nemco Monster FryKutter

Dimensions 260 x 468 x 385 (mm)
 Material Cast Aluminium / Stainless Steel (Blades)
 Weight 11,2 kg
 Cutting Sizes 6,5 mm / 10 mm / 13 mm
 Article Number 56450A-1 / 56450A-2 / 56450A-3
Price 2608 €



Nemco Easy Chopper

Dimensions 203 x 203 x 483 (mm)
 Material Cast Aluminium / Stainless Steel (Blades)
 Weight 2,7 kg
 Cutting Sizes 6,5 mm / 10 mm / 13 mm
 Article Number 55500-1 / 55500-2 / 55500-3
Price 482 €



Nemco Easy Chopper 2

Dimensions 254 x 254 x 520 (mm)
 Material Cast Aluminium / Stainless Steel (Blades)
 Weight 4,1 kg
 Cutting Sizes 6,5 mm / 10 mm / 13 mm
 Article Number 56500-1 / 56500-2 / 56500-3
Price 588 €



Nemco Monster Airmatic FryKutter

Dimensions 736 x 380 x 355 (mm)
 Material Cast Aluminium / Stainless Steel (Blades)
 Weight 18,2 kg
 Cutting Sizes 6,5 mm / 10 mm / 13 mm
 Article Number 56455-1 / 56455-2 / 56455-3
Price 4596 €



Edlund Titan Max Cut

Dimensions 240 x 610 x 760 (mm)
 Material Stainless Steel
 Weight 17,2 kg
 Cutting Sizes 6,5 mm / 10 mm / 13 mm
 Article Number 29110 / 29210 / 29310
Price Quoted



Nemco Easy Chopper 3

Dimensions 248 x 304 x 495 (mm)
 Material Cast Aluminium / Stainless Steel (Blades)
 Weight 5,0 kg
 Cutting Sizes 6,5 mm / 10 mm / 13 mm
 Article Number 57500-1 / 57500-2 / 57500-3
Price 690 €



Nemco Easy LettuceKutter

Dimensions 330 x 457 x 508 (mm)
 Material Cast Aluminium / Stainless Steel (Blades)
 Weight 7,7 kg
 Cutting Sizes 12,7 mm / 19,0 mm / 25,4 mm
 Article Number 55650-3 / 55650-6 / 55650
Price 1383 € / 1322 € / 1149 €

Slicers / Wedgers



Edlund ARC

Dimensions	240 x 510 x 660 (mm)
Material	Stainless Steel
Weight	14,5 kg
Cutting Sizes	4,75 mm / 6,5 mm / 10 mm
Article Number	30100 / 30200 / 30300
Price	Quoted



Edlund ARC XL

Dimensions	240 x 590 x 740 (mm)
Material	Stainless Steel
Weight	20,0 kg
Cutting Sizes	4,75 mm / 6,5 mm / 10 mm
Article Number	30400 / 30500 / 30600
Price	Quoted



Nemco Easy Wedger

Dimensions	203 x 203 x 483 (mm)
Material	Cast Aluminium / Stainless Steel (Blades)
Weight	2,7 kg
Cutting Sizes	6,5 mm / 10 mm / 13 mm
Article Number	55550-4 / 55550-6 / 55550-8 / 55550-10
Price	324 €



Nemco Tomato Tamer

De-stem tomatoes quickly and efficiently with this Tomato Shark that features an ergonomic handle.	
Material	Stainless Steel
Article Number	537
Price	10 €

Tomato Slicers



Nemco Easy Tomato Slicer

Dimensions	184 x 390 x 210 (mm)
Material	Cast Aluminium / Stainless Steel (Blades)
Weight	3,6 kg
Cutting Sizes	4,75 mm / 6,5 mm / 10 mm
Article Number	55600-1 / 55600-2 / 55600-3
Price	582 €



Nemco Easy Tomato Slicer 2

Dimensions	190 x 473 x 240 (mm)
Material	Cast Aluminium / Stainless Steel (Blades)
Weight	4,3 kg
Cutting Sizes	4,75 mm / 6,5 mm / 10 mm
Article Number	56600-1 / 56600-2 / 56600-3
Price	803 €



Nemco Roma Tomato Slicer

Dimensions	155 x 378 x 140 (mm)
Material	Cast Aluminium / Stainless Steel (Blades)
Weight	4,5 kg
Cutting Sizes	4,75 mm / 6,5 mm / 10 mm
Article Number	56610-1 / 56610-2 / 56610-3
Price	999 €



Nemco Tomato Laser Slicer

Dimensions	477 x 305 x 292 (mm)
Material	Stainless Steel
Weight	9,0 kg
Cutting Sizes	4,75 mm / 6,5 mm / 10 mm
Article Number	30700 / 30800 / 30900
Price	Quoted

Cheese & Chicken Slicers



Nemco Easy Cheeser

Dimensions	115 x 172 x 318 (mm)
Material	Cast Aluminium / Stainless Steel (Blades)
Weight	1,7 kg
Cutting Sizes	10 mm / 20 mm
Article Number	55300A-1 / 55300A
Price	479 € / 459 €



Nemco Easy Cheeser Mozzarella Slicer

Dimensions	172 x 318 x 450 (mm)
Material	Cast Aluminium / Stainless Steel (Blades)
Weight	1,7 kg
Cutting Size	8 mm
Article Number	55300A-516D
Price	635 €



Nemco Easy Cheese Blocker

Dimensions	305 x 312 x 546 (mm)
Material	Cast Aluminium / Stainless Steel (Blades)
Weight	4,5 kg
Article Number	55350A
Price	702 €



Nemco Easy Chicken Slicer

Dimensions	172 x 343 x 165 (mm)
Material	Cast Aluminium / Stainless Steel (Blades)
Weight	4,1 kg
Cutting Sizes	6,5 mm / 10 mm / 13 mm
Article Number	55975-2 / 55975-1 / 55975
Price	702 € / 690 € / 655 €

Potato & Onion Slicers



Nemco Easy Onion Slicer 2

Dimensions	254 x 482 x 762 (mm)
Material	Cast Aluminium / Stainless Steel (Blades)
Weight	7,7 kg
Cutting Sizes	4,75 mm / 6,5 mm / 10 mm / 13 mm
Article Number	56750-1 / 56750-2 / 56750-3 / 56750-4
Price	1126 € / 1058 €



Nemco Easy Flowering Onion Cutter

Dimensions	343 x 285 x 432 (mm)
Material	Cast Aluminium / Stainless Steel (Blades)
Weight	5,0 kg
Article Number	55700
Price	1172 €



Nemco Spiral Fry PotatoKutter

Dimensions	140 x 559 x 229 (mm)
Material	Cast Aluminium / Stainless Steel (Blades)
Weight	1,8 kg
Article Number	55050AN / 55050AN-R / 55050AN-G 55050AN-WR / 55050AN-CT
Price	Quoted



Nemco PowerKut PotatoKutter

Dimensions	254 x 438 x 222 (mm)
Material	Stainless Steel
Weight	8,8 kg
Article Number	55150B-C / 55150B-R / 55150B-G 55150B-WR / 55150B-CT / 55150B-WCT
Price	Quoted

Ren & Skär

Colour Coded Cutting Boards



RS-S20-GR



RS-S20-BR



RS-S20-BL

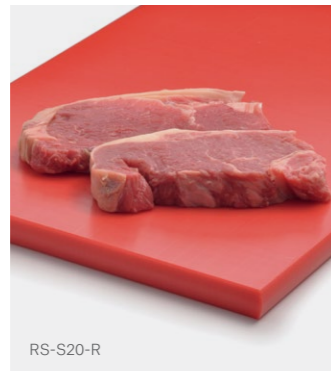

RS-S20-R



RS-S20-V



RS-S20-GU

Ren & Skär Colour Coded Cutting Boards

Our cutting boards are made using high quality material and the colour coding enables safe food handling. Made of hard-pressed polyethylene, these quality boards are intended to perform under high frequency use.

Material High Density Polyethylene (HMW)
 Certificate EU-Directive 2002/72/EC

Cutting Board Large 20 mm

Dimensions 500 x 355 x 20 mm

Article Number	RS-S20-GR	Green	Fruit / Salad
	RS-S20-BR	Brown	Vegetables
	RS-S20-BL	Blue	Fish / Shellfish
	RS-S20-R	Red	Raw Meat
	RS-S20-V	White	Dairy Products
	RS-S20-GU	Yellow	Cooked Meat

Price 54 € (per unit)

All prices in Euros (€) excluding VAT & shipping costs.



RS-S12-GR



RS-S12-BR



RS-S12-BL

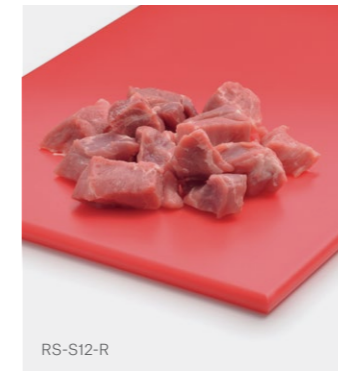

RS-S12-R



RS-S12-V



RS-S12-GU

Cutting Board Large 12 mm

Dimensions 500 x 355 x 12 mm

Article Number	RS-S12-GR	Green	Fruit / Salad
	RS-S12-BR	Brown	Vegetables
	RS-S12-BL	Blue	Fish / Shellfish
	RS-S12-R	Red	Raw Meat
	RS-S12-V	White	Dairy Products
	RS-S12-GU	Yellow	Cooked Meat

Price 39 € (per unit)

Cutting Board Small 12 mm

Dimensions 355 x 250 x 12

Article Number	RS-L12-GR	Green	Fruit / Salad
	RS-L12-BR	Brown	Vegetables
	RS-L12-BL	Blue	Fish / Shellfish
	RS-L12-R	Red	Raw Meat
	RS-L12-V	White	Dairy Products
	RS-L12-GU	Yellow	Cooked Meat

Price 24 € (per unit)

Bill Rails



Bill Rail TabGrabber 455 mm

Dimensions 455 x 60 x 10 mm
 Material Anodised Aluminium
 Article Number LUTG-455
Price 39 €



Bill Rail TabGrabber 610 mm

Dimensions 610 x 85 x 10 mm
 Material Anodised Aluminium
 Article Number LUTG-610
Price 43 €

Keep track of your orders with our bill rails!



Bill Rail TabGrabber 914 mm

Dimensions 914 x 85 x 10 mm
 Material Anodised Aluminium
 Article Number LUTG-914
Price 48 €



Bill Rail TabGrabber 1220 mm

Dimensions 1220 x 60 / 85 x 10 mm
 Material Anodised Aluminium
 Article Number LUTG-1220
Price 54 €

Choose between our new and our old model.

All prices in Euros (€) excluding VAT & shipping costs.

Plate Heaters



Stayhot Plate Heater 2006/AT

Dimensions Ø 450 mm / H 570 mm
 Capacity 30-40 Plates
 Voltage / Power 230 V / 600 W
 Article Number 2006-AT
Price Quoted



Stayhot Plate Heater 2008/AT

Dimensions Ø 450 mm / H 800 mm
 Capacity 45-60 Plates
 Voltage / Power 230 V / 600 W
 Article Number 2008-AT
Price Quoted

Grill Scraper



Grill Scraper Griddle Tamer II

Dimensions 355 x 60 x 157 (mm)
 Material Cast Aluminium / Stainless Steel (Blades)
 Article Number GT-404
Price 54 €

All our products are made with high quality materials to ensure a long shelf life. If something against the odds would break – or if you're just in need of an accessory – it is very easy to choose from our range of spare parts and accessories.

Spare Parts & Accessories

Strip Heaters



Heating Element
V-570 / VL-750

Power 575 W
Art.-Nr. ST570
Price 78 €



Heating Element
640 / VL-820

Power 575 W
Art.-Nr. ST640
Price 79 €



Heating Element
V-945 / VL-1125

Power 750 W
Art.-Nr. ST945
Price 89 €



Heating Element
V-1250 / VL-1430

Power 1000 W
Art.-Nr. ST1250
Price 99 €



Light Fixture

Art.-Nr. ST1090
Price 34 €



Light Bulb 25 W

Art.-Nr. ST1091
Price 8 €



Mounting Plates (Pair)

Art.-Nr. ST1088
Price 22 €



Mounting Chains (Pair)

Length 1500 mm
Art.-Nr. ST1085
Price 36 €



Reflector

Art.-Nr. ST1087
Price 12 €



Rheostat

Art.-Nr. ST1093
Price 43 €



Power Switch

Art.-Nr. ST1092
Price 14 €



Power Cable

Art.-Nr. ST1089
Price 19 €



Signal Lamp

Art.-Nr. ST1096
Price 18 €

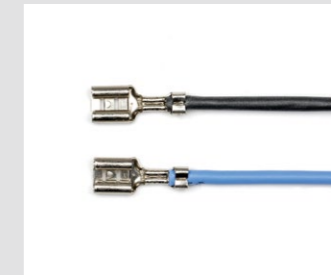

Complete Cable Set
V Models (without lights)

Art.-Nr. ST1086-V
Price 22 €

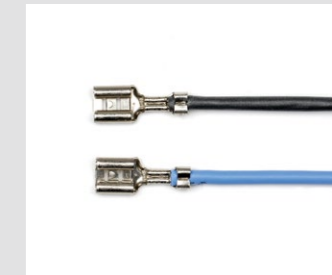

Complete Cable Set
VL Models (with lights)

Art.-Nr. ST1086-VL
Price 22 €

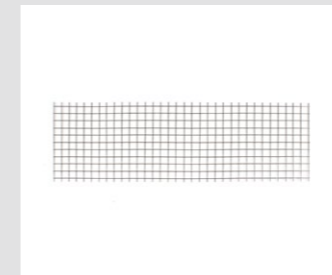

Safety Grill V-570 / VL-750

Dimensions 445 x 128 mm
Art.-Nr. ST1097
Price 12 €

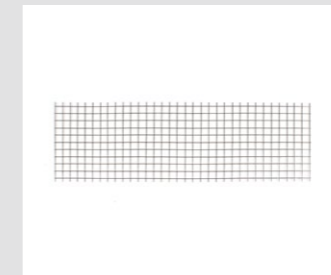

Safety Grill V-640 / VL-820

Dimensions 515 x 128 mm
Art.-Nr. ST1098
Price 13 €

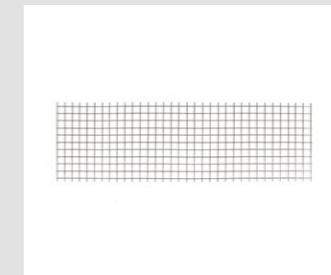

Safety Grill V-945 / VL-1125

Dimensions 820 x 128 mm
Art.-Nr. ST1099
Price 14 €

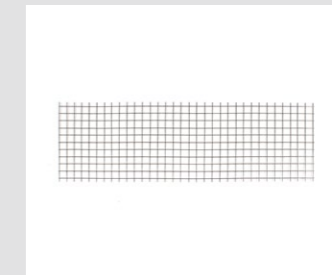

Safety Grill V-1250 / VL-1430

Dimensions 1125 x 128 mm
Art.-Nr. ST10991
Price 15 €

If any component from our strip heaters stops working, it is really easy to order the relevant spare part to lengthen the shelf life of the product.

Spare Parts & Accessories Heat Lamps



IR Light Bulb 250 W / White

Infrared light bulb with stain-proof hard glass. White light (2700K).

Power 250 W
Art.-Nr. IR-250-V
Price 21 €



IR Light Bulb 250 W / Red

Infrared light bulb with stain-proof hard glass. Red light.

Power 250 W
Art.-Nr. IR-250-R
Price 19 €



IR Light Bulb 175 W / White

Power 175 W
Art.-Nr. IR-175-V
Price 89 €



Power Switch / Classic

For models 1224 / 1223 / 1222.

Art.-Nr. 1224-STR
Price 11 €



Retractable Cord / Exclusive

For models 22001 / 23001

Art.-Nr. 22001-H
Price 81 €



Retractable Cord / Classic

For all Classic 1224 models.

Art.-Nr. 1224-H
Price 81 €



Adapter for ERCO Track

Adapter for the ERCO track.

Art.-Nr. 1079055000
Price 59 €



Coupler for ERCO Track

Connect tracks with this coupler.

Art.-Nr. 1079315000
Price 12 €



ERCO Track / 1 m White

Material Aluminium
Dimensions 1000 x 120 x 30
No. of Lamps Max 3
Art.-Nr. 21100-3
Price 91 €



ERCO Track / 2 m White

Material Aluminium
Dimensions 2000 x 120 x 30
No. of Lamps Max 6
Art.-Nr. 21100-6
Price 133 €



ERCO Track / 3 m White

Material Aluminium
Dimensions 3000 x 120 x 30
No. of Lamps Max 10
Art.-Nr. 21100-10
Price 199 €



ERCO Track / 4 m White

Material Aluminium
Dimensions 4000 x 120 x 30
No. of Lamps Max 13
Art.-Nr. 21100-13
Price 242 €

Spare Parts & Accessories Combi Plates (Combi/Hot/Cold)



Mounting Frame GN 1/1

Mounting frame for easy installation of recessed plates.

Art.-Nr. SHC-MR-GN-1/1
Price 325 €



Mounting Frame GN 2/1

Mounting frame for easy installation of recessed plates.

Art.-Nr. SHC-MR-GN-2/1
Price 345 €



Mounting Frame GN 3/1

Mounting frame for easy installation of recessed plates.

Art.-Nr. SHC-MR-GN-3/1
Price 365 €



Silicone Seal / White

Silicone seal for our recess plates. 1 tube per GN size.

Size 310 ml
Art.-Nr. SHC-SFV
Price 7 €



Silicone Seal / Black

Silicone seal for our recess plates. 1 tube per GN size.

Size 310 ml
Art.-Nr. SHC-SFS
Price 7 €



Silicone Seal / Dark Grey

Silicone seal for our recess plates. 1 tube per GN size.

Size 310 ml
Art.-Nr. SHC-SFA
Price 7 €



Mounting Kit

Mounting kit consisting of four screws for all recess models.

Art.-Nr. SHC-JS
Price 33 €



Control Panel for Combi Plates

Control panel for our combi plates. Including connecting cables.

Art.-Nr. R-03-1
Price 114 €



Control Panel for Hot Plates

Control panel for our combi plates. Including connecting cables.

Art.-Nr. R-03-2
Price 114 €



Control Panel for Cold Plates

Control panel for our combi plates. Including connecting cables.

Art.-Nr. R-03-3
Price 114 €

Spare Parts & Accessories

Hot Trays



Power Cable Fixed

Art.-Nr. WP-EL-FAST
Price 14 €



Power Cable Removable

Art.-Nr. WP-EL
Price 14 €



Handle WP-250 / WP-350

Art.-Nr. WP-250-H
Price 28 €

Art.-Nr. WP-350-H
Price 30 €

Soup Heaters



Extra Stainless Steel Insert 5.1 L

Art.-Nr. BL-402-EX
Price 42 €

Chill Trays



Staychill Cover GN 1/1

Cover with open short side

Art.-Nr. SCH-1
Price 48 €



Staychill Cover GN 1/1

Cover with open long side

Art.-Nr. SCH-2
Price 48 €



Rubber Feet / Chill Trays

Art.-Nr. SCH-3
Price 8 € (4-Pack)

Spare Parts & Accessories

Food Preparation Equipment



Blade Assembly / Easy Wedger

Art.-Nr. 428-6
Cutting Sizes 6 Wedges
Price Quoted



Blade Assembly / Easy Wedger

Art.-Nr. 428-8
Cutting Sizes 8 Wedges
Price Quoted

We sell a wide range of spare parts for our food preparation equipment. Below is a small selection. Please inquire if you have any questions!



Blade Assembly Easy FryKutter

Art.-Nr. 55424-2
Cutting Sizes 9,5 mm
Price Quoted



Blade Assembly Easy Tomato Slicer 2

Art.-Nr. 566-2
Cutting Sizes 6,5 mm
Price Quoted

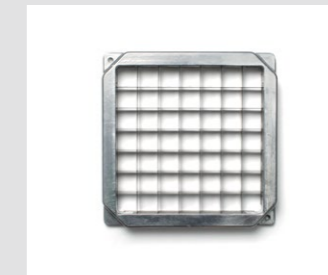

Blade Assembly LettuceKutter

Art.-Nr. 55485
Cutting Sizes 25,4 mm
Price Quoted



Blade Assembly Easy Onion Slicer 2

Art.-Nr. 56539-1
Cutting Sizes 4,75 mm
Price Quoted

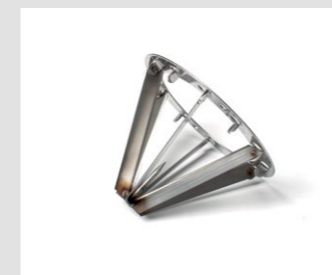

Blade Assembly Le-Jo Wedge Tamer

Art.-Nr. E601-1
Cutting Sizes 6 Wedges
Price Quoted



Pusher Head Le-Jo Tomato Tamer

Art.-Nr. 531-2
Cutting Sizes 4,75 mm
Price Quoted



Handle Le-Jo Tomato Tamer

Art.-Nr. 530-4
Price Quoted

Our History

We are a family business with over 30 years of experience. We combine tradition and industry knowledge with innovation and enthusiasm.

1986



Started From The Bottom

Eva and Pelle Lobelius establish Lobelius Agenturer and run it out of their basement.

1987



First Impression

Our first logo, drawn up by our founder, Per Lobelius.

1993



Old School Ads

Even though we sell the same products, the ads we published 26 years ago looked a bit different compared to today.

1996



First Home

After 10 years in the basement, the company moves out and settles down in its own house, right next door.

2015



A Family Business

The second generation of Lobelius join the action as Karl, Felix and Erik gradually become involved in the business.

2017



The Red House

After more than 30 years of business, we finally move out of the residential area and into a warehouse that accomodates our growing operation.

2018



Growth Spurt

With a new home for the business, we also start to grow in terms of numbers. New, talented colleagues result in fresh energy and ideas, all of which contribute to a stimulating workplace.

2019



Hot Food in Focus

A completely new product range is taking shape, with new heat lamps, strip heaters and hot trays, all specifically designed for the restaurants of tomorrow.

Contact Details

If ever in the area, we would love to welcome you to our office, where we base our stock, production and exhibition, all under one roof!

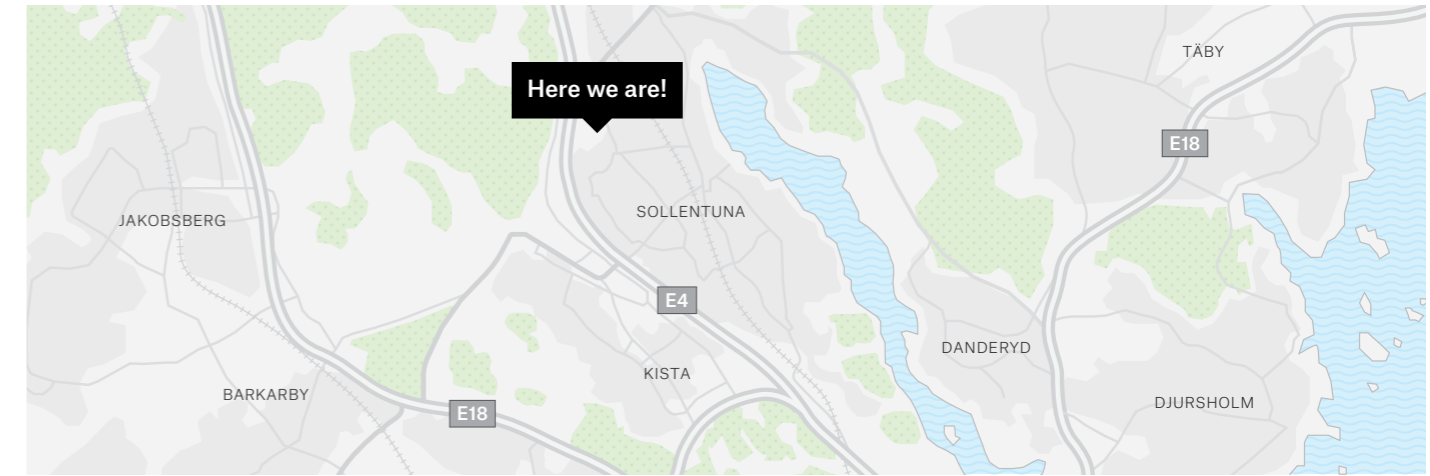

Call Us

+46 8 35 79 15

Visit Us

Knistavägen 1B

Email Us

info@stayhot.se

191 62 Sollentuna

Online

www.stayhot.se

Sweden

Contact us directly



Karl Lobelius

CEO



Felix Lobelius

Head Marketing & Communication

Direct +46 8 551 051 96

Email karl@stayhot.se

Direct +46 8 551 051 92

Email felix@stayhot.se

Get in touch.

info@stayhot.se
www.stayhot.se
+46 8 35 79 15

Knistavägen 1B
191 62 Sollentuna
Sweden

STAYHOT